

THE REDEFINITION OF PRE RIG TRUSS. NO JOKE.



**THE MLT SERIES.
ENGINEERED
IN GERMANY.**

H^{OF}

**THE REDEFINITION
OF PRE RIG TRUSS.
NO JOKE.**

**THE MLT SERIES.
ENGINEERED IN GERMANY.**

No big tour and no festival without Pre Rig Truss.
But also for smaller concerts, Pre Rig Truss is more and more used.
Our MLT Series offers you Pre Rig Truss at its best-engineered in Germany.
Here you can find the overview of our MLT Series.

CONTENT

MLT THREE

page 4 - 17

The famous MLT ONE and MLT TWO Pre Rig Trusses have received a new member to complete the MLT series: The MLT THREE. The most important features of the MLT THREE are: open at the bottom, extended telescopic legs, optional rail system.

The MLT THREE is fully compatible with the MLT TWO and MLT ONE.

MLT TWO

page 18 - 31

The MLT TWO contains a lot of benefits when it comes to fast and easy set up and dismantling. The key features of the MLT TWO are: rotatable forks, folding dolly, adjustable legs.

The MLT TWO is fully compatible with the MLT THREE and MLT ONE.

MLT ONE

page 32 - 41

The MLT ONE is the ideal transportation solution for high-quality lighting technology. Additional transport cases are no longer needed, and the cabling is directly suspended in the MLT ONE, which considerably reduces set-up and dismantling times. In addition, convenient stacking is possible to save space.

The MLT ONE is fully compatible with the MLT TWO and MLT THREE.

MLT ZERO

page 42 - 47

The MLT ZERO is the little sister of the MLT ONE. Stackable transportation, fast assembly and dismantling times as well as a good price-performance ratio are the impressive features of the MLT ZERO. This Pre Rig Truss is based on the cone connector system and thus guarantees quick and easy connection of the trusses.

MLT FRAME

page 48 - 55

The MLT FRAME is the optimal companion for touring and smaller concerts and a transportation solution for triangular and box trusses up with up to 40 cm width. Lighting can remain suspended and wired in the truss during transportation. The length of the MLT FRAME can be varied using different conitubes. The most important features of the MLT FRAME are: Compatible with triangular and box trusses, for truss lengths between 1-5 metres, height-adjustable dolly.

ACCESSORIES



page 56 - 60

Accessories like truss pins and r-clips, as well as accessories for transportation like wheels and truss protection rings.

MLT THREE



The famous MLT ONE and MLT TWO Pre Rig Trusses have received a new member to complete the MLT series: The MLT THREE. The most important features of the new MLT THREE at a glance:

-  **Bottom open**
-  **Extended telescopic legs**
-  **Optional rail system**

The MLT THREE has no closed head frame and is open at the bottom. This makes it easier to mount moving lights or video modules in the truss.

MLT THREE



Bottom open

The MLT THREE has no closed head frame and is open at the bottom. This makes it easier to mount moving lights or video modules in the truss.

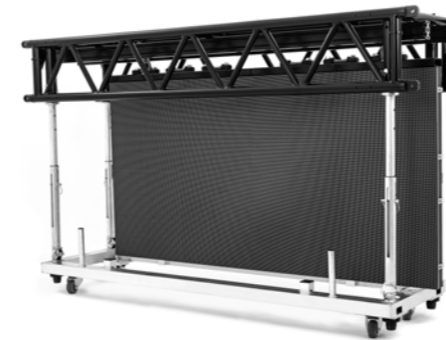

Extended telescopic legs

The dolly of the MLT THREE has extended telescopic legs that allow you to mount complete video modules including the hanging frame in the truss and leave them in the truss during transportation.



Optional rail system

A double rail system is available as an option, which makes mounting the units in the truss even easier: the units can be suspended at 2 different levels. A lowering device is not required.

MLT THREE

Tube	48,3 x 4,5 mm
Bracing	30 x 3 mm
Material	Aluminium EN AW 6082 T6
Color	RAL 9005

Permissible loadings without limit by deflection according DIN 13814 Fairground.

Gleichstreckenlast Distributed load (UDL)		Einzellast in jedem Kreuzpunkt Single load in every single crossing point		Durchbiegung Deflection
m	kg/m	kg		mm
4	1200	420		14
5	800	420		22
6	612	420		31,2
7	447	391		42,1
8	339	271		49
9	265	198		58
10	212	176		83,7
11	174	120		100,1
12	145	108		117,7
13	121	98		136,2
14	103	90		155,6
15	88	82		176

MLT THREE TRUSS AND FOLDING DOLLY



Bottom open

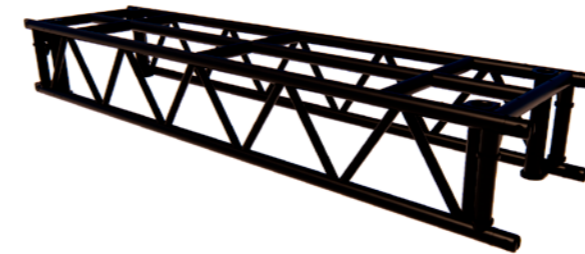
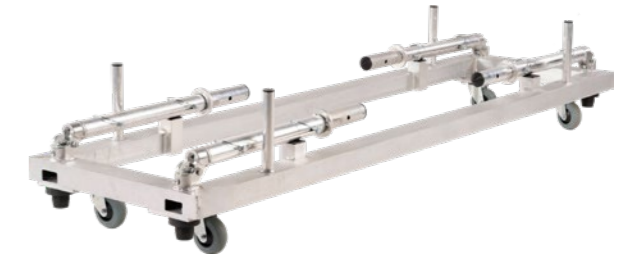

Truss/Length	Art. No.
1200 mm	113350MLT31200BK
1600 mm	113350MLT31600BK
2000 mm	113350MLT32000BK
2400 mm	113350MLT32400BK
3000 mm	113350MLT33000BK
3200 mm	113350MLT33200BK

Dolly/Length	Art. No.
1600 mm	114350MLT21600BK
2400 mm	114350MLT22400BK
3200 mm	114350MLT23200BK

MLT THREE ACCESSORIES

RAIL SYSTEM

A rail system is optionally available for the MLT THREE, which makes mounting the units in the truss even easier. The rail system is a double rail system. This means that the units can be hung on 2 different levels and no lowering device is required. The rail system also allows you to mount the lighting at the transitions between two trusses and to create seamless transitions between the video modules in the trusses.

Art. No.: 11499192000



RUNNER FOR RAIL SYSTEM

Runner to be hung in the double rail system.

Art. No.: 1149918



PROTECTION COVER

The protection cover for the MLT THREE Pre Rig Truss offers the sensitive lighting technology protection from rain and sun during set-up and dismantling and, if required, also during the show.

By pulling the protection cover under the truss instead of over the MLT THREE, the moving lights with unblocked PAN-TILT are secured during transport. Rolled up, the protection cover remains on the truss during the show and is virtually invisible.

Art. No.: 114350MLT253



LOWERING SET

The lowering set is used to mount smaller equipment a little lower in the MLT THREE Pre Rig Truss. The lowering set is attached below the central tube in the truss. It is adjustable in 4 different heights and can be adapted accordingly to the respective size of the lamp.

Art. No.	Lowering Set/Length
114350MLT2612	1200 mm
114350MLT2616	1600 mm
114350MLT2624	2400 mm
114350MLT2630	3000 mm
114350MLT2632	3200 mm



MLT THREE ACCESSORIES

LOWERING T-BAR

The Lowering T-Bar is used to mount smaller devices a little lower in the MLT THREE.

The Lowering T-Bar is attached below the central main tube. It is steplessly adjustable up to 100 mm height and adapts to the respective size of the lamp.

Art. No.: 114350MLT2601



DOLLY ATTACHMENT FOR VERTICAL CURVED USE

Aluminium dolly attachment for vertical curved use.

Art. No.: 114350MLT271



DISTANCE HOLDER

It serves as both a distance holder and a stacking aid between the MLT THREE dolly and the MLT THREE truss, creating a 150 mm gap between the top of the Pre Rig Truss and the bottom of the dolly. The distance holder is black powder coated. One set consists of 2 pieces.

Art. No.: 114350MLT2DH



GIZMO LOAD BALANCER - WLL 1000 KG

Black powder coated steel Gizmo which can also be used as a load balancer; WLL 1000 kg. The Gizmo has one side with male forks, the other side with female forks as connection between two MLTs.

Art. No.: 172350MLT10001

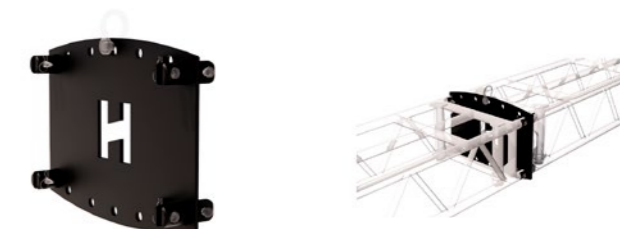

RIGGING FRAME

The rigging frame is for vertical use of the MLT THREE Pre Rig Truss. It is made of steel and comes incl. bolt set and 3.25t shackle; WLL 1000 kg.

Art. No.: 172350MLT10003



GIZMO - WLL 500 KG

Black powder-coated steel Gizmo; WLL 500 kg.

Art. No.: 172350MLT05002



MLT THREE ACCESSORIES

FORKLIFT ADAPTER

The steel adapter protects truss, cable and other technology during transportation with a forklift truck.

Art. No.: 114350MLT2FL

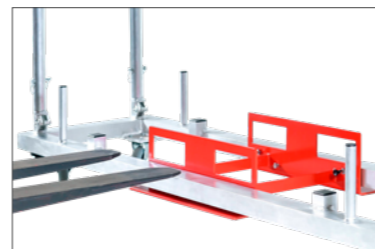
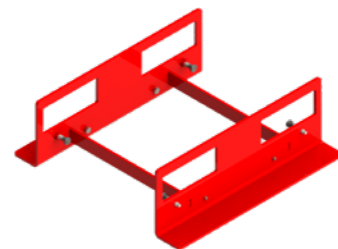

ACCESSORIES BOX

Suitable for all MLT TWO dollies.
Ideal for storing the bolt, clips, r-clips, cables and other accessories.
The box can simply be placed into the dolly.

Art. No.: 114350MLT2AB

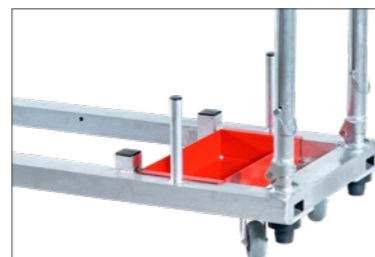
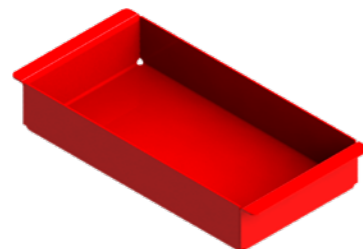

STEEL FORK FEMALE

incl. lock ring

Art. No.: 114350MLT201



STEEL FORK MALE

incl. lock ring

Art. No.: 114350MLT202



MOUNTING TOOL FOR FEMALE

for screwing in the rotatable forks

Art. No.: 114350MLT251



MOUNTING TOOL FOR MALE

for screwing in the rotatable forks

Art. No.: 114350MLT252



CURVING TOOL

for adjusting the screw forks from 10 to 70 mm

Art. No.: 114350MLT2TOOL1



FIXING TOOL

for locking the screw forks

Art. No.: 114350MLT2TOOL2



SPACER 100 MM

suitable for forming circles

Art. No.: 114350MLT2SP100



SPACER 200 MM

suitable for forming circles

Art. No.: 114350MLT2SP200



SPACER 300 MM

suitable for forming circles

Art. No.: 114350MLT2SP300



SPACER 400 MM

suitable for forming circles

Art. No.: 114350MLT2SP400



Mount lighting equipment at the transitions between two trusses.



Create seamless transitions between the video modules in the trusses.

MLT TWO



The MLT TWO contains a lot of benefits when it comes to fast and easy set up and dismantling. The features of the MLT TWO are as follows:

 **Rotatable forks**

 **Adjustable legs**

 **Folding dolly**



 **Rotatable forks**

Create curved truss systems without extra components.



 **Adjustable legs**

Use the telescopic feature to minimize dismantling time.



 **Folding dolly**

Fold and stack dollies to use shipping space efficiently.

MLT TWO

Tube	48,3 x 4,5 mm
Bracing	30 x 3 mm
Material	Aluminium EN AW 6082 T6
Color	RAL 9005
Height	1030 mm (incl. dolly)

Permissible loadings without limited by deflection taking account of the DIN 13814 Fairground.

	Gleichstreckenlast Distributed load (UDL)		Durchbiegung Deflection		Einzellast in jedem Kreuzpunkt Single load in every single crossing point		Durchbiegung Deflection	
	m ft	total kg/m lbs/ft	mm inch	kg lbs	mm inch			
6 19,7	3178,5 7007,4	529,8 356	2,2	410 903,9	2,2			
8,4 27,6	2261 4984,7	269,2 180,9	4,4	210,5 464,1	4,4			
10,8 35,4	1667,5 3676,2	154,4 133,7	7,3	123 271,2	7,3			
12 39,4	1470,5 3241,9	122,5 82,3	9,1	98 216,1	9,1			

MLT TWO TRUSS AND FOLDING DOLLY



Rotatable forks

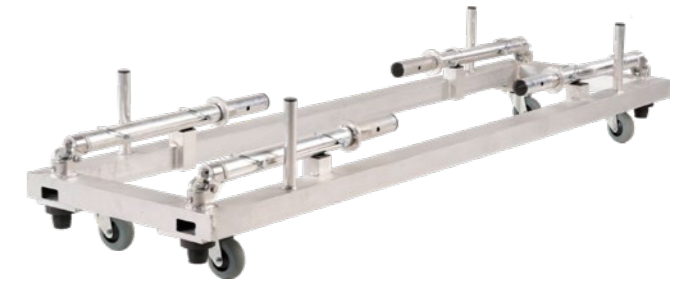

Truss/Length	Art. No.
1200 mm	113350MLT21200BK
1600 mm	113350MLT21600BK
2400 mm	113350MLT22400BK
3000 mm	113350MLT23000BK
3200 mm	113350MLT23200BK

Dolly/Length	Art. No.
1200 mm	114350MLT21200BK
1600 mm	114350MLT21600BK
2400 mm	114350MLT22400BK
3000 mm	114350MLT23000BK
3200 mm	114350MLT23200BK

MLT TWO ACCESSORIES

PROTECTION COVER

The protection cover for the MLT TWO Pre Rig Truss offers the sensitive lighting technology protection from rain and sun during set-up and dismantling and, if required, also during the show. By pulling the protection cover under the truss instead of over the MLT TWO, the moving lights with unblocked PAN-TILT are secured during transport. Rolled up, the protection cover remains on the truss during the show and is virtually invisible.

Art. No.: 114350MLT253



LOWERING SET

The lowering set is used to mount smaller equipment a little lower in the MLT TWO Pre Rig Truss without interfering with the lower tubes of the MLT TWO. The lowering set is attached below the central tube in the truss. It is adjustable in 4 different heights and can be adapted accordingly to the respective size of the lamp.

Art. No.	Lowering Set/Length
114350MLT2612	1200 mm
114350MLT2616	1600 mm
114350MLT2624	2400 mm
114350MLT2630	3000 mm
114350MLT2632	3200 mm



LOWERING T-BAR

The Lowering T-Bar is used to mount smaller devices a little lower in the MLT TWO, to avoid interfering of the lower main tubes of the MLT TWO. The Lowering T-Bar is attached below the central main tube. It is steplessly adjustable up to 100 mm height and adapts to the respective size of the lamp.

Art. No.: 114350MLT2601



DISTANCE HOLDER

It serves as both a distance holder and a stacking aid between the MLT TWO dolly and the MLT TWO truss, creating a 150mm gap between the top of the Pre Rig Truss and the bottom of the dolly. The distance holder is black powder coated. One set consists of 2 pieces.

Art. No.: 114350MLT2DH



RIGGING FRAME

The rigging frame is for vertical use of the MLT TWO Pre Rig Truss. It is made of steel and comes incl. bolt set and 3.25 t shackle; WLL 1000 kg.

Art. No.: 172350MLT10003



DOLLY ATTACHMENT FOR VERTICAL CURVED USE

Aluminium dolly attachment for vertical curved use.

Art. No.: 114350MLT271



MLT TWO ACCESSORIES

GIZMO LOAD BALANCER - WLL 1000 KG

Black powder coated steel Gizmo which can also be used as a load balancer; WLL 1000 kg. The Gizmo has one side with male forks, the other side with female forks as connection between two MLTs.

Art. No.: 172350MLT10001



STEEL FORK FEMALE

incl. lock ring

Art. No.: 114350MLT201



STEEL FORK MALE

incl. lock ring

Art. No.: 114350MLT202

GIZMO - WLL 500 KG

Black powder-coated steel Gizmo; WLL 500 kg.

Art. No.: 172350MLT05002



MOUNTING TOOL FOR FEMALE

for screwing in the rotatable forks

Art. No.: 114350MLT251



MOUNTING TOOL FOR MALE

for screwing in the rotatable forks

Art. No.: 114350MLT252



CURVING TOOL

for adjusting the screw forks from 10 to 70 mm

Art. No.: 114350MLT2TOOL1



FIXING TOOL

for locking the screw forks

Art. No.: 114350MLT2TOOL2

FORKLIFT ADAPTER

The steel adapter protects truss, cable and other technology during transportation with a forklift truck.

Art. No.: 114350MLT2FL

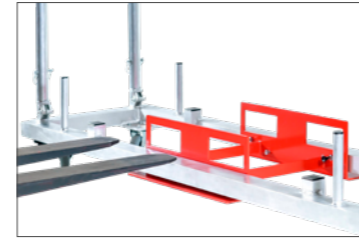
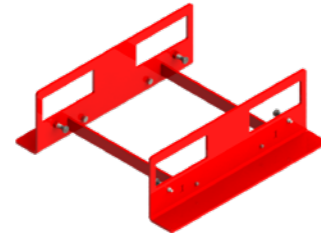

SPACER 100 MM

suitable for forming circles

Art. No.: 114350MLT2SP100



SPACER 200 MM

suitable for forming circles

Art. No.: 114350MLT2SP200

ACCESSORIES BOX

Suitable for all MLT TWO dollies. Ideal for storing the bolt, clips, r-clips, cables and other accessories. The box can simply be placed into the dolly.

Art. No.: 114350MLT2AB

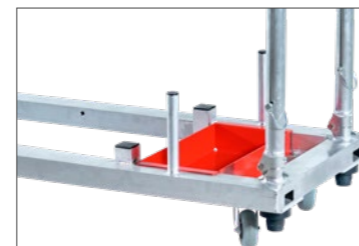
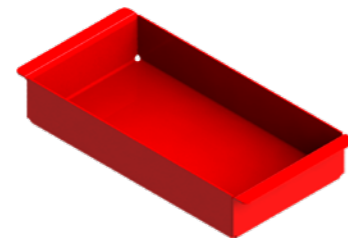

SPACER 300 MM

suitable for forming circles

Art. No.: 114350MLT2SP300



SPACER 400 MM

suitable for forming circles

Art. No.: 114350MLT2SP400

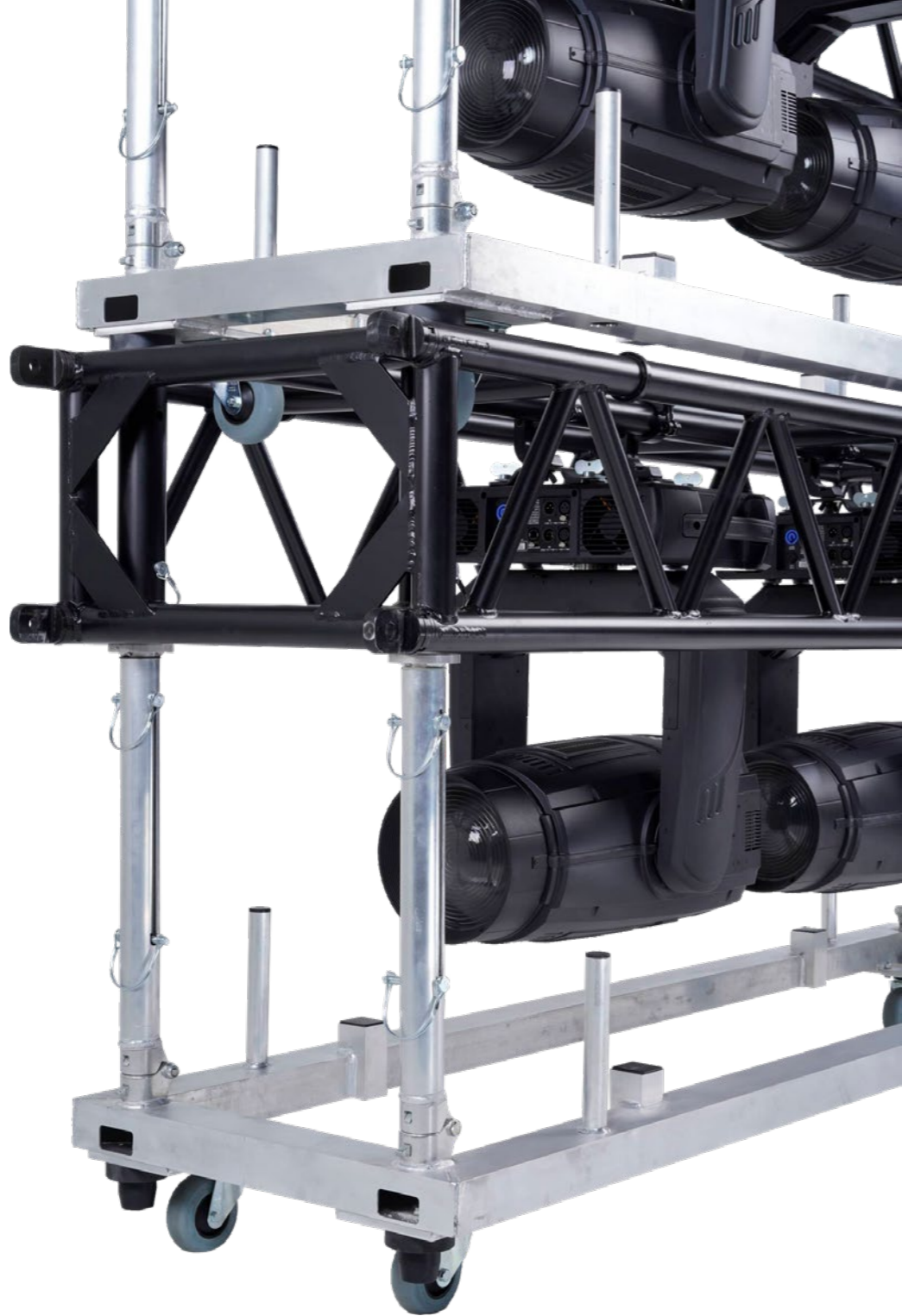

Rotatable forks for curving.





Image: © Michael Ray Vera Cruz Angeles

Fast and easy set up and dismantling



Image: © EventElevator

Create a curved truss system

MLT ONE



The MLT ONE is the transportation solution for high-quality lighting technology. Additional transport cases are no longer needed, the cabling is directly suspended in the MLT ONE, which considerably reduces set-up and dismantling times. In addition, convenient stacking is possible to save space.

 **Easy dolly storage**

 **Stackable for transportation**

 **Lightweight dolly**

MLT ONE

Tube	48,3 x 4,5 mm
Bracing	30 x 3 mm
Material	Aluminium EN AW 6082 T6
Color	RAL 9005
Height	1030 mm (incl. dolly)

Permissible loadings without limited by deflection taking account of the DIN 13814 Fairground.

		Gleichstreckenlast Distributed load (UDL)		Durchbiegung Deflection		Einzellast in jedem Kreuzpunkt Single load in every single crossing point		Durchbiegung Deflection	
m	ft	total	kg/m lbs/ft	mm inch		kg lbs		mm inch	
6	19,7	3178,5	529,8	2,2		410		2,2	
		7007,4	356			903,9			
8,4	27,6	2261	269,2	4,4		210,5		4,4	
		4984,7	180,9			464,1			
10,8	35,4	1667,5	154,4	7,3		123		7,3	
		3676,2	133,7			271,2			
12	39,4	1470,5	122,5	9,1		98		9,1	
		3241,9	82,3			216,1			

MLT ONE TRUSS AND WHEEL FRAME SET



Truss with fixed forks



Truss/Length	Art. No.
1600 mm	113350MLT1600BK
2400 mm	113350MLT2400BK
3200 mm	113350MLT3200BK



Dollyset

Dolly/Length	Art. No.
1600 mm	114350MLT1600BK
2400 mm	114350MLT2400BK
3200 mm	114350MLT3200BK

MLT ONE CORNER AND WHEEL FRAME SET

Art. No.: 114350MLT41BK + 114350MLT41DBK
4-way corner and dolly*



Description	Art. No.	Dolly	Art. No.
4-way Corner C41 (cross)	114350MLT41BK	for 4-way C41	114350MLT41DBK
Load Balancer	113350MLTLBBK		

Art. No.: 113350MLTLBBK
incl. rigging point 750 kg (steel)



RIGGING FRAME

The rigging frame is for vertical use of the MLT ONE Pre Rig Truss. It is made of steel and comes incl. bolt set and 3.25 t shackle; WLL 1000 kg.

Art. No.: 172350MLT10003



GIZMO LOAD BALANCER - WLL 1000 KG

Black powder coated steel Gizmo which can also be used as a load balancer; WLL 1000 kg. The Gizmo has one side with male forks, the other side with female forks as connection between two MLTs.

Art. No.: 172350MLT10001



GIZMO - WLL 500 KG

Black powder-coated steel Gizmo; WLL 500 kg.

Art. No.: 172350MLT05002





DOLLYDOLLY
suitable for 8 dollies*

Art. No.: 114350MLT62

* Delivered will be only the silver holder for the dollies. You use one dolly set to build the dollydolly and then your other dollies turned around fit into the holder.



SPACER 100 MM
suitable for forming circles

Art. No.: 114350MLT2SP100



SPACER 200 MM
suitable for forming circles

Art. No.: 114350MLT2SP200



SPACER 300 MM
suitable for forming circles

Art. No.: 114350MLT2SP300



SPACER 400 MM
suitable for forming circles

Art. No.: 114350MLT2SP400



Stackable incl. fixtures



Preparation before the show



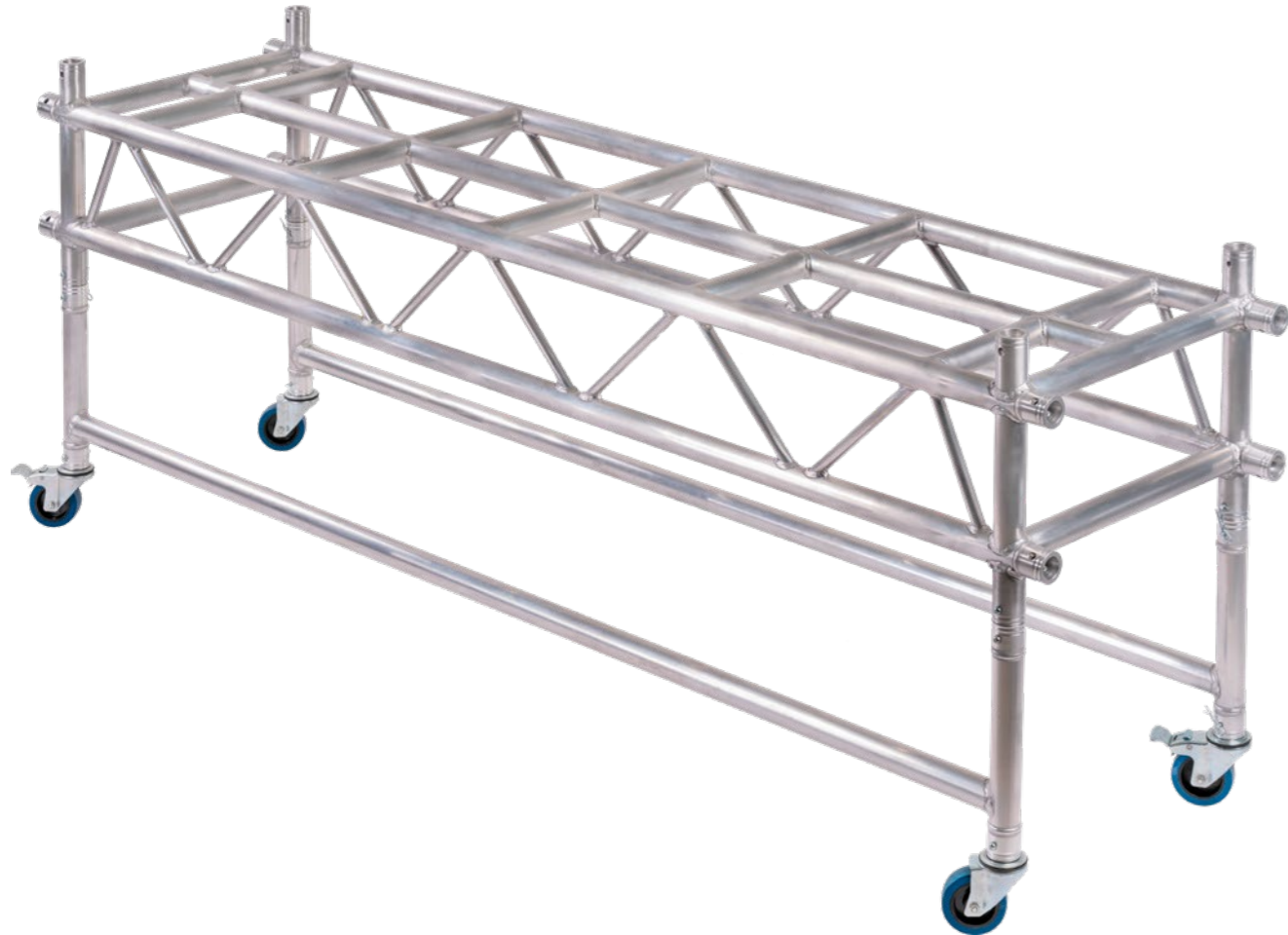

Dolly upside-down

MLT ZERO



The MLT ZERO is the little sister of the MLT ONE.
This Pre Rig Truss is based on the cone connector system and thus guarantees quick and easy connection of the trusses.

The most important features of the MLT ZERO:

-  **Conical connector**
-  **Stackable for transportation**
-  **Great price performance ratio**

MLT ZERO

Tube	48 x 3 mm
Bracing	20 x 2 mm
Material	Aluminium EN AW 6082 T6
Color	aluminium
Height	1030 mm (incl. dolly)

Permissible loadings with limited by deflection taking account of the DIN 13814 Fairground.

		Gleichstreckenlast Distributed load (UDL)		Durchbiegung Deflection		Einzellast in jedem Kreuzpunkt Single load in every single crossing point		Durchbiegung Deflection	
m	ft	total	kg/m lbs/ft	mm inch		kg lbs		mm inch	
6	19,7	1920	320	24,6		160		25,4	
		4232,9	215,0			352,7			
8	26,2	1280	160	38,3		75		36,2	
		2821,9	107,5			165,3			
10	32,8	950	95	56,4		50		59,3	
		2094,4	63,8			110,2			
12	39,4	720	60	76,5		30		76,5	
		1587,3	40,3			66,1			

MLT ZERO TRUSS AND DOLLY



Conical connection



Dollyset

Truss/Length	Art. No.
1000 mm	H11290MLT1000
1500 mm	H11290MLT1500
2000 mm	H11290MLT2000
2500 mm	H11290MLT2500
3000 mm	H11290MLT3000
3500 mm	H11290MLT3500

Dolly/Length	Art. No.
1000 mm	H11290MLT1001
1500 mm	H11290MLT1501
2000 mm	H11290MLT2001
2500 mm	H11290MLT2501
3000 mm	H11290MLT3001
3500 mm	H11290MLT3501

MLT ZERO ACCESSORIES AND SPARE PARTS



SPACER 105 MM
male

Art. No.: 11199105M



CONI TUBE 500 MM
HOFKON 290-1

Art. No.: 11129010500



SPACER 125-170 MM
adjustable; male

Art. No.: 11199ADJ



DOLLY WHEEL
set of wheels for MLT ZERO dollies

Art. No.: 15910016



SPACER 210 MM
male

Art. No.: 11199210M



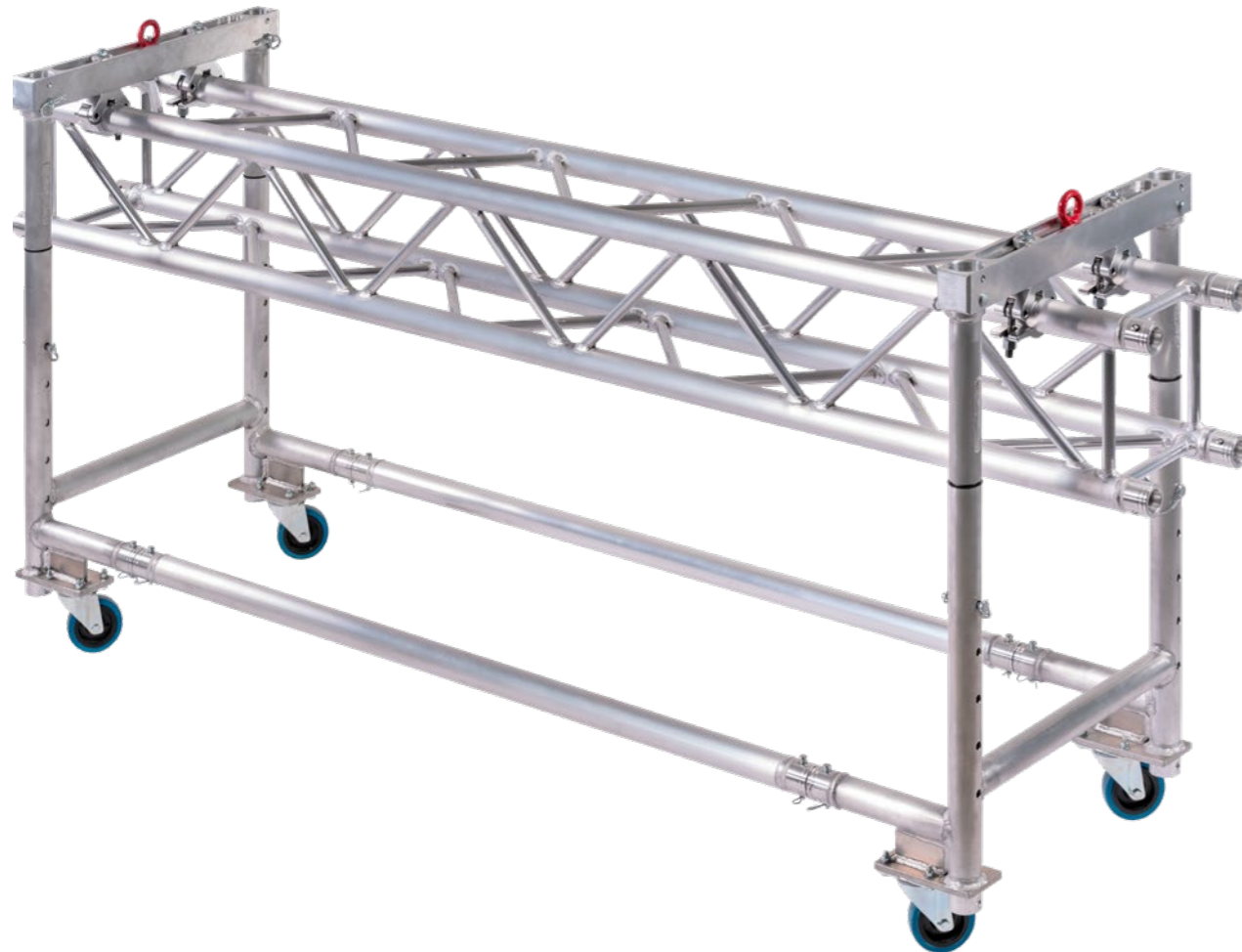

MLT FRAME



The MLT FRAME is the optimal companion for touring and smaller concerts and a transportation solution for triangular and box trusses up with up to 40 cm width. Lighting can remain suspended and wired in the truss during transportation. The length of the MLT FRAME can be varied using different conitubes.

The most important features of the MLT FRAME at a glance:

-  **Compatible with triangular and box trusses**
-  **Truss lengths of 1-5 metres**
-  **Height adjustable dolly**

MLT FRAME

Tube	48 x 3 mm
Material	Aluminium EN AW 6082 T6
Color	aluminium
Height (adjustable frame)	915 - 1320 mm

IMPORTANT FACTS

- Fits for all truss lengths between 1,0 m and 5,0 m
- Trusses up to 40 cm width fit in
- Integrated truss-adapter up to 750 kg according to DGUV-17
- Depending on frame height (telescopic) and inside height of the truck, up to 3 MLT FRAMES can be stacked

YOUR BENEFIT

- Time saving because fixture can be prepared before the show
- Cost-saving because it is compatible with all 3-point and 4-point trusses with max. 40 cm width
- Suitable for transportation (incl. fixture) without using cases

NOTE

Permissible loadings depend on the truss used in each case.

MLT FRAME HEIGHT ADJUSTABLE

The MLT FRAME is a height adjustable dolly system with gizmo or square aluminium.



MLT FRAME H40

incl. 2 x square aluminium tubes 60 x 60 mm

Art. No.: 157H40



MLT FRAME H41

incl. 1 x square aluminium tube 60 x 60 mm
incl. 1 x gizmo

Art. No.: 157H41



MLT FRAME H42

incl. 2 x gizmo

Art. No.: 157H42



Height adjustable from 915 up to 1320 mm.



Delivery without truss and conitubes.

ACCESSORIES & SPARE PARTS

The length is variable by the chosen conical tubes.
You choose the length of the conical tube 1000 mm less than the length of the truss you want to hang in the MLT FRAME.



Truss length	suitable conitube	Art. No.
1000 mm	-	
1500 mm	500 mm	11129010500
2000 mm	1000 mm	11129011000
2500 mm	1500 mm	11129011500
3000 mm	2000 mm	11129012000
3500 mm	2500 mm	11129012500
4000 mm	3000 mm	11129013000
4500 mm	3500 mm	11129013500
5000 mm	4000 mm	11129014000



BAR FOR MLT FRAME

aluminium tube 60 x 60mm
2 x CJS Halfcoupler 750 kg/50 mm

Art. No.: 157H4BAR



GIZMO FOR MLT FRAME

incl. high-strength ring nut M12
2 x CJS Halfcoupler 750 kg/50 mm

Art. No.: 157H4GIZ



Height adjustable



Stackable



For different truss types

ACCESSORIES

We offer nearly every truss accessory:
MLT accessories like truss pins and r-clips, as well as accessories
for transportation like wheels and truss protection rings.
We have the balanced portfolio for you.



TRUSS PROTECTION RING

for 50 mm tube

Art. No.: 1582911



DOLLY DOLLY

for MLT ONE; for 8 dollies

Art. No.: 114350MLT62

SPACER



SPACER 100 MM

for MLT THREE and MLT TWO
suitable for forming circles

Art. No.: 114350MLT2SP100



SPACER 200 MM

for MLT THREE and MLT TWO
suitable for forming circles

Art. No.: 114350MLT2SP200



SPACER 300 MM

for MLT THREE and MLT TWO
suitable for forming circles

Art. No.: 114350MLT2SP300



SPACER 400 MM

for MLT THREE and MLT TWO
suitable for forming circles

Art. No.: 114350MLT2SP400



SPACER 105 MM

for MLT ZERO; male

Art. No.: 11199105M



SPACER 210 MM

for MLT ZERO; male

Art. No.: 11199210M



SPACER 125-170 MM

for MLT ZERO
adjustable; male

Art. No.: 11199ADJ

CONNECTORS



CONICAL CONNECTOR
for MLT ZERO

Art. No.: 1119912



TRUSSPIN STANDARD
for MLT ZERO

Art. No.: 1119913



TRUSSPIN M8
for MLT ZERO

Art. No.: 1119913S



TRUSSPIN STANDARD
for MLT THREE, MLT TWO, MLT ONE

Art. No.: 1139913



TRUSSPIN HACKA
for MLT THREE, MLT TWO, MLT ONE

Art. No.: 1139919



LINCHPIN
for MLT THREE, MLT TWO, MLT ONE, MLT FRAME

Art. No.: HOF30021



COTTER PIN 2MM SINGLE
for MLT THREE, MLT TWO, MLT ONE

Art. No.: 1119925



COTTER PIN 3MM DOUBLE
for MLT THREE, MLT TWO, MLT ONE

Art. No.: 1119927

HOFKON 290-1 TRUSS

for MLT FRAME



mm	Art. No.
500	11129010500
1000	11129011000
1500	11129011500
2000	11129012000
2500	11129012500
3000	11129013000
3500	11129013500
4000	11129014000

MLT THREE AND MLT TWO

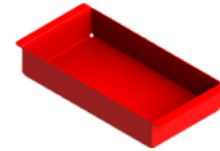

ACCESSORIES BOX
Suitable for MLT THREE and MLT TWO dollies. Ideal for storing the bolts, clips, cables and other accessories. The box can simply be placed into the dolly.

Art. No.: 114350MLT2AB

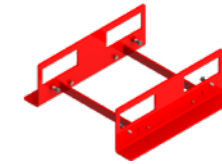

FORKLIFT ADAPTER
The steel adapter protects truss, cable and other technology during transportation with a forklift truck.

Art. No.: 114350MLT2FL



CURVING TOOL
for adjusting the screw forks from 10 to 70 mm

Art. No.: 114350MLT2TOOL1



FIXING TOOL
for locking the screw forks

Art. No.: 114350MLT2TOOL2



STEEL FORK FEMALE
incl. lock ring

Art. No.: 114350MLT201



STEEL FORK MALE
incl. lock ring

Art. No.: 114350MLT202



MOUNTING TOOL FOR FEMALE
for screwing in the rotatable forks

Art. No.: 114350MLT251



MOUNTING TOOL FOR MALE
for screwing in the rotatable forks

Art. No.: 114350MLT252

WHEELS



BLUE WHEEL PENN ELCOM MAGNETIC CASTOR WITHOUT BRAKE

for MLT THREE, MLT TWO, MLT ONE, MLT FRAME

fitting diameter: 100 mm
height: 128 mm
load capacity: 160 kg (static 320 kg)

Art. No.: 15910018



SOFTSHOCK WHEEL

for MLT TWO, MLT ONE

fitting diameter: 80 mm
height: 108 mm
load capacity: 120 kg

Art. No.: 114350MLT2SSW



WHEEL SET

for MLT ZERO

wheel incl. half conical connector
fitting diameter: 100 mm
height: 128 mm
load capacity: 160 kg

Art. No.: 15910016



HOF Alutec
Metallverarbeitungs GmbH & Co. KG
Brookstraße 8
49497 Mettingen
Germany
Phone +49 (0) 54 52-97 33-10
info@h-of.de
www.h-of.de