

OBSEIDIAN™

CONTROL SYSTEMS

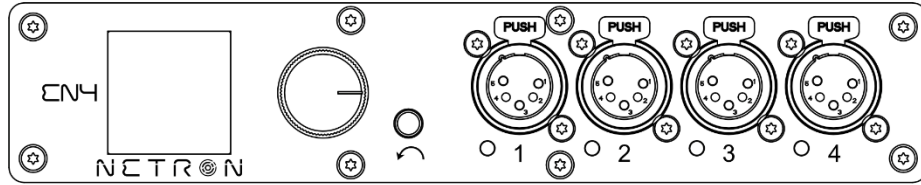

EN4

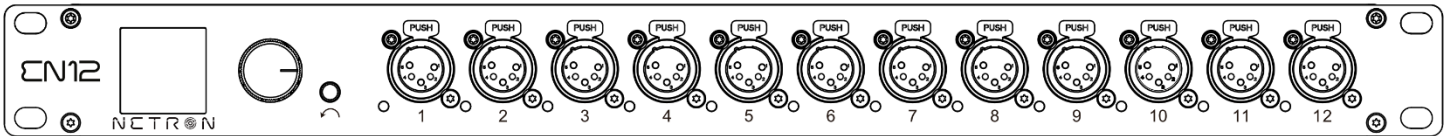

EN12

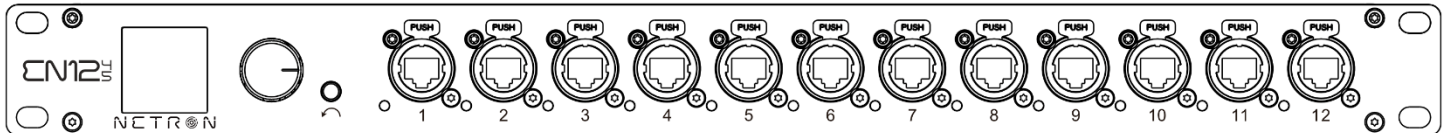

EN12S

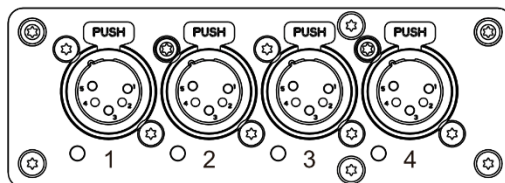

EP4

NETRON

User Guide

©2022 **OBSIDIAN CONTROL SYSTEMS** all rights reserved. Information, specifications, diagrams, images, and instructions herein are subject to change without notice. Obsidian Control Systems logo and identifying product names and numbers herein are trademarks of ADJ PRODUCTS LLC. Copyright protection claimed includes all forms and matters of copyrightable materials and information now allowed by statutory or judicial law or hereinafter granted. Product names used in this document may be trademarks or registered trademarks of their respective companies and are hereby acknowledged. All non – ADJ brands and product names are trademarks or registered trademarks of their respective companies.

OBSIDIAN CONTROL SYSTEMS and all affiliated companies hereby disclaim all liabilities for property, equipment, building, and electrical damages, injuries to any persons, and direct or indirect economic loss associated with the use or reliance of any information contained within this document, and/or because of the improper, unsafe, insufficient, and negligent assembly, installation, rigging, and operation of this product.

ELATION PROFESSIONAL B.V.

Junostraat 2 | 6468 EW Kerkrade, The Netherlands
+31 45 546 85 66

Art-Net

This device incorporates Art-Net™, Designed by and Copyright Artistic License Holdings Ltd

FCC STATEMENT

This device complies with Part 15 of the FCC Rules. Operation is subject to the following two conditions: (1) this device may not cause harmful interference, and (2) this device must accept any interference received, including interference that may cause undesired operation.

FCC RADIO FREQUENCY INTERFERENCE WARNINGS & INSTRUCTIONS

This product has been tested and found to comply with the limits as per Part 15 of the FCC Rules. These limits are designed to provide reasonable protection against harmful interference in a residential installation. This device uses and can radiate radio frequency energy and, if not installed and used in accordance with the included instructions, may cause harmful interference to radio communications. However, there is no guarantee that interference will not occur in a particular installation. If this device does cause harmful interference to radio or television reception, which can be determined by turning the device off and on, the user is encouraged to try to correct the interference by one or more of the following methods:

- Reorient or relocate the device.
- Increase the separation between the device and the receiver.
- Connect the device to an electrical outlet on a circuit different from which the radio receiver is connected.
- Consult the dealer or an experienced radio/TV technician for help.



Energy Saving Matters (EuP 2009/125/EC)

Saving electric energy is a key to help protecting the environment. Please turn off all electrical products when they are not in use. To avoid power consumption in idle mode, disconnect all electrical equipment from power when not in use. Thank you!

Document Version: An updated version of this document may be available online. Please check www.obsidiancontrol.com for the latest revision/update of this document before beginning installation and use.

Date	Document Version	Note
12/17/19	1.0	INITIAL RELEASE
12/27/19	1.5	Added Art-Net copyright
01/06/20	2.0	DateUpdated software
01/21/20	2.5	Updated Menu Options
09/21/20	3.0	Updated Firmware to V2.4
02/02/21	3.5	Updated Firmware to V2.6 for EN4, EN12, EP4; & updated silkscreens for EN4 & EN12
03/29/21	4.0	Added EN12-45
05/25/22	4.5	Updated FCC Statement

CONTENTS

GENERAL INFORMATION	4
OVERVIEW	5
CONNECTIONS	6
MENU:	
NAVIGATION	11
HOME SCREEN	12
PRESETS	13
NETRON PRESETS	14
CUES	15
DMX PORTS	16
REMOTE INPUT	17
VIEW AND TEST	18
IP ADDRESS	20
SYSTEM	21
INFORMATION	22
WEB REMOTE CONFIGURATION	23
WEB REMOTE MENU	24
FIRMWARE UPDATES	40

GENERAL INFORMATION

INTRODUCTION

Please read and understand the instructions in this manual carefully and thoroughly before attempting to operate this device. These instructions contain important safety and use information.

CUSTOMER SUPPORT

Contact your local Obsidian Controls Systems dealer or distributor for any product related service and support needs. Also visit forum.obsidiancontrol.com with questions, comments or suggestions.

OBSIDIAN CONTROL SERVICE EUROPE – Monday – Friday 08:30 to 17:00 CET
+31 45 546 85 63 | support@obsidiancontrol.com

OBSIDIAN CONTROL SERVICE USA – Monday – Friday 08:30 to 17:00 PST
(866) 245 – 6726 | support@obsidiancontrol.com

OVERVIEW

INTRODUCTION

The Netron devices offer unique and powerful DMX management features. Most settings can be accessed from the intuitive display and menu system.

All settings are available from the integrated web page, which allows remote access to this device from any web-browser. The multi-purpose EN4, EP4, EN12, and EN12-45 EtherDMX Gateways essentially package Art-Net and sACN conversion, Merger, DMX patch-bay, and a DMX scene recorder into one device.

KEY FEATURES

- sACN and Art-Net to DMX conversion
- Factory defined NETRON presets
- 10 User Presets
- 99 Cues with Fade Time, Hold Time and Cue linking
- External contact closures to trigger cues and preset recall (EN12 only)
- DMX Monitor
- DMX and Ethernet Test Generator

SOFTWARE AND OPERATION

This document provides safety information and mechanical installation instructions.

For setup and operation of all software features, please update the devices to the latest release. Download and study the full user guides from <http://obsidiancontrol.com/netron>.

The NETRON Ether-DMX devices offer a comprehensive and easy to use feature set, and are continuously improving. It is advised to periodically check for updates on the Obsidian product pages.

CONNECTIONS

DMX CONNECTIONS (EN12)

All DMX Output connections are 5pin female XLR; however, the pin – out on all sockets is pin 1 to shield, pin 2 to cold (–), and pin 3 to hot (+). Pins 4 and 5 are not used.

Carefully connect DMX cables to the respective ports.

To prevent damaging the DMX ports, provide strain relief and support. Avoid connecting FOH Snakes to the ports directly.

Certain functions may require adapters (purchased separately), such as a 5 pole XLR male to 5 pole XLR male.

Pin	Connection
1	Com
2	Data –
3	Data +
4	Not connected
5	Not connected

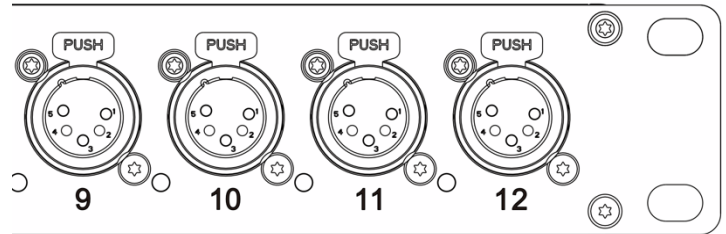

DMX CONNECTIONS (EN12-45)

All DMX Output connections are RJ45; Pin1: DATA+, Pin2: DATA -, Pin7+8; Ground (ESTA Compliant)

Carefully connect RJ45 cables to the respective ports.

To prevent damaging the ports, provide strain relief and support. Avoid connecting FOH Snakes to the ports directly.

L	Connection
1	Data +
2	Data -
3	Not connected
4	Not connected
5	Not connected
6	Not connected
7	Com
8	Com
Shield	Earth

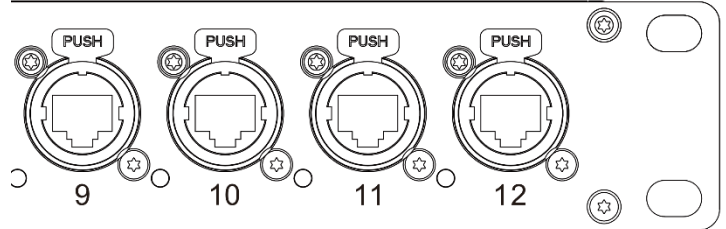

ETHERNET DATA CONNECTION

The Ethernet cable is connected on the back of the gateway into the port labeled A or B. Devices can be daisy chained, but it is recommended not to exceed 10 Netron devices in one chain. Because these devices use locking RJ45 connectors, and the use of locking RJ45 ethernet cables is recommended, any RJ45 connector is suitable.

To connect multiple devices to an EtherDMX Source, an Ethernet switch is required to split the data into the desired number of streams.

The Ethernet connection is also used to connect a computer to the Netron device for remote configuration via a web browser. To access the web interface, simply enter the IP address shown in the display in any web browser connected to the device. Information about the web access can be found in the manual.

CONNECTIONS: EN4 (FRONT & REAR PANELS)

FRONT CONNECTIONS

- (4) 5pin DMX/RDM optically isolated ports
- Ports are bidirectional for DMX In and Output
- Full color OLED display
- Encoder w. Push to Select / Exit Button

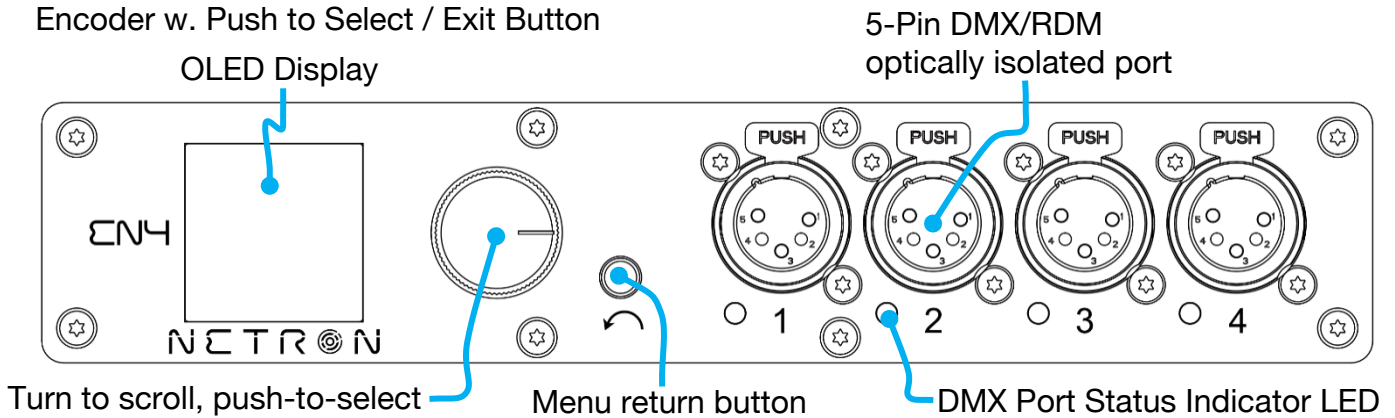

DMX PORTS STATUS INDICATOR LEDs

LED Color	Solid	Blink	Flashing/Strobing
DMX PORTS RED	Error		
DMX PORTS GREEN	DMX In	DMX Lost	
DMX PORTS BLUE	DMX Out Stable	DMX Lost	
DMX PORTS WHITE			Flash on RDM packets

All LEDs are dimmable and can be turned off via the Menu/System/Display menu.

REAR CONNECTIONS

- Power In/Thru
- (2) Gigabit RJ45 network connections (1x POE)

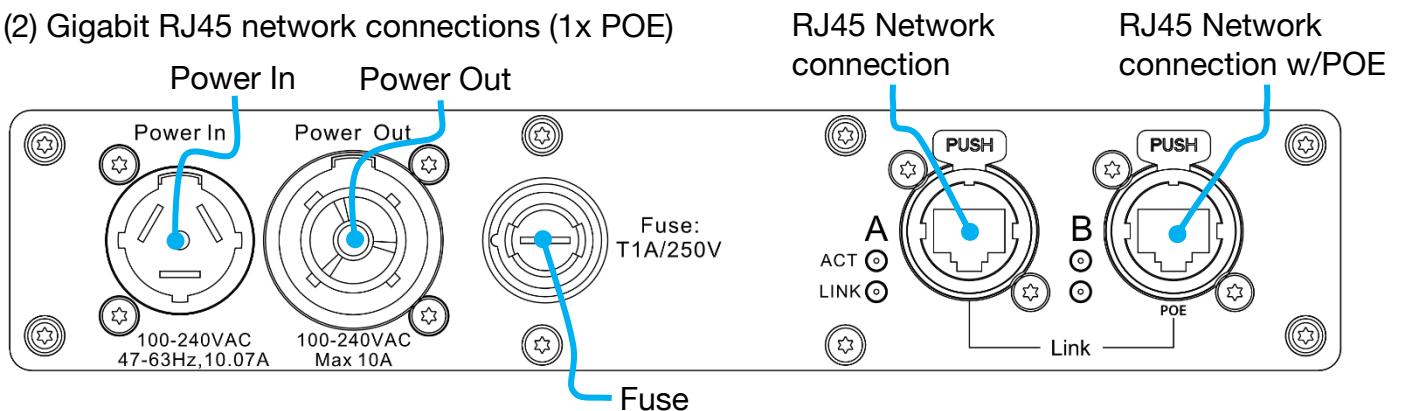

CONNECTIONS: EN12 (FRONT & REAR PANELS)

FRONT CONNECTIONS

- (12) 5pin DMX/RDM optically isolated ports
- Ports are bidirectional for DMX In and Output
- Full color OLED display
- Encoder w. Push to Select / Exit Button

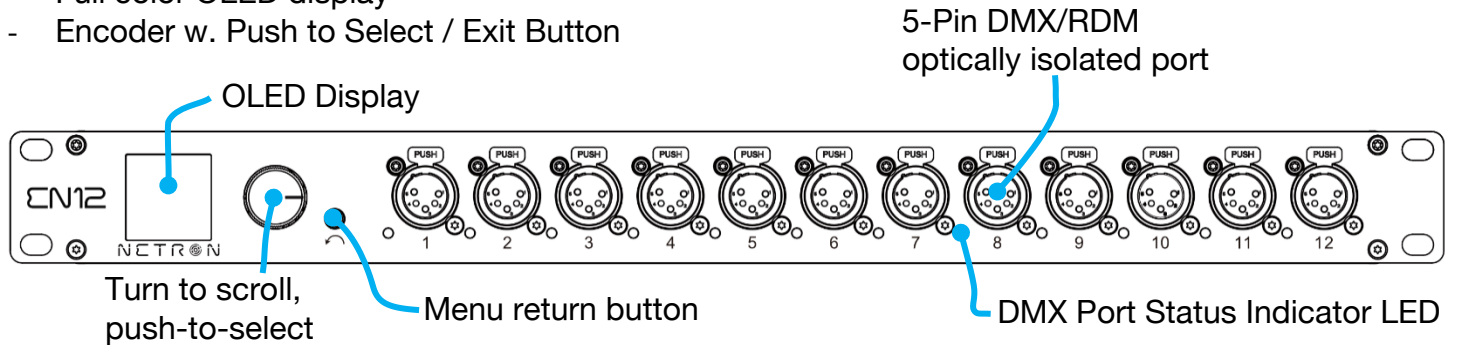

DMX PORTS STATUS INDICATOR LEDs

LED Color	Solid	Blink	Flashing/Strobing
DMX PORTS RED	Error		
DMX PORTS GREEN	DMX In	DMX Lost	
DMX PORTS BLUE	DMX Out	DMX Lost	
DMX PORTS WHITE			Flash on RDM packets

All LEDs are dimmable and can be turned off via the Menu/System/Display menu.

REAR CONNECTIONS

- (2) Gigabit RJ45 network connections (1x POE)
- (10) Contact Closures (Terminal Block)

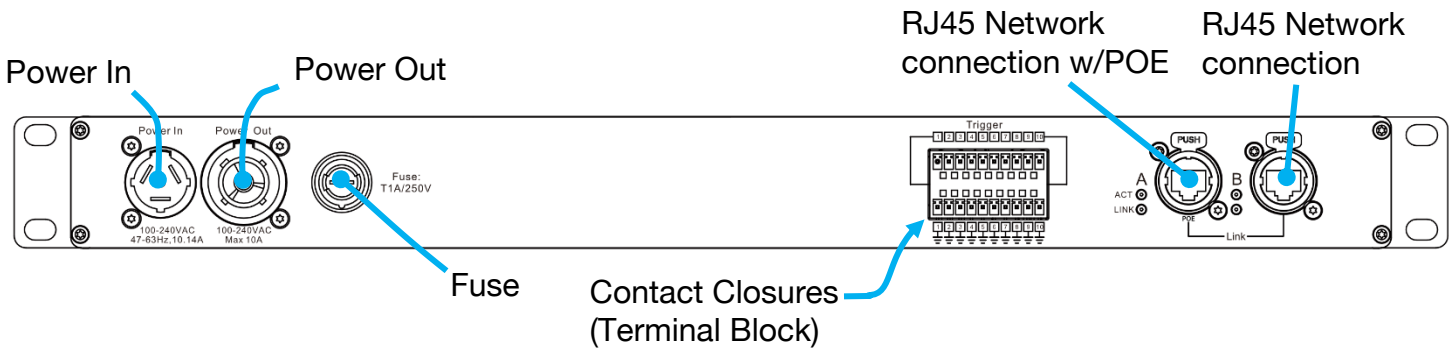

CONNECTIONS: FRONT & REAR PANELS EN12-45

FRONT CONNECTIONS

- (12) RJ45 DMX/RDM optically isolated ports
- Ports are bidirectional for DMX In and Output
- Full color OLED display
- Encoder w. Push to Select / Exit Button

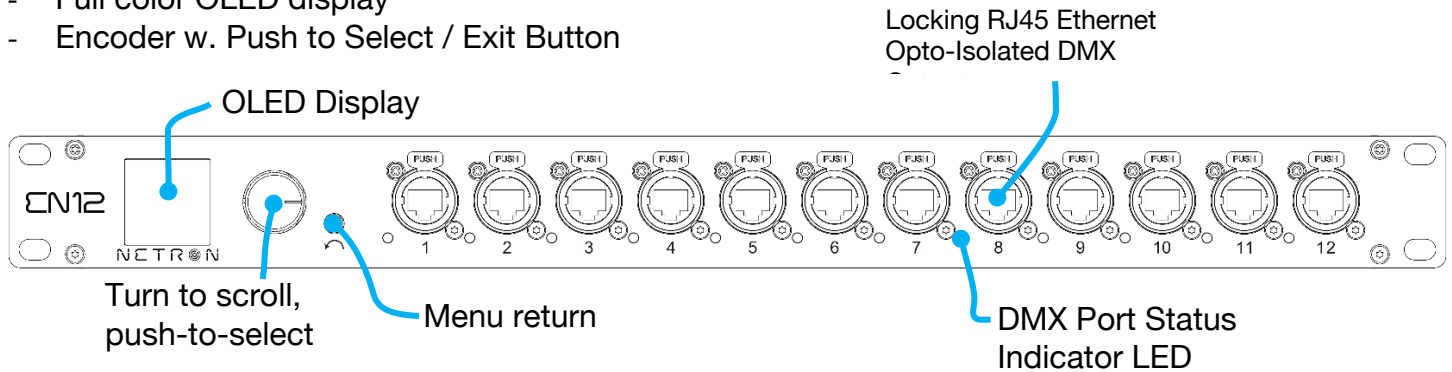

RJ45 PORTS STATUS INDICATOR LEDs

LED Color	Solid	Blink	Flashing/Strobing
DMX PORTS RGB	Error		
DMX PORTS RGB	DMX In	DMX Lost	
DMX PORTS RGB	DMX Out	DMX Lost	
DMX PORTS WHITE			Flash on RDM packets

All LEDs are dimmable and can be turned off via the Menu/System/Display menu.

REAR CONNECTIONS

- (2) RJ45 network connections (1x POE)
- (10) Contact Closures (Terminal Block)

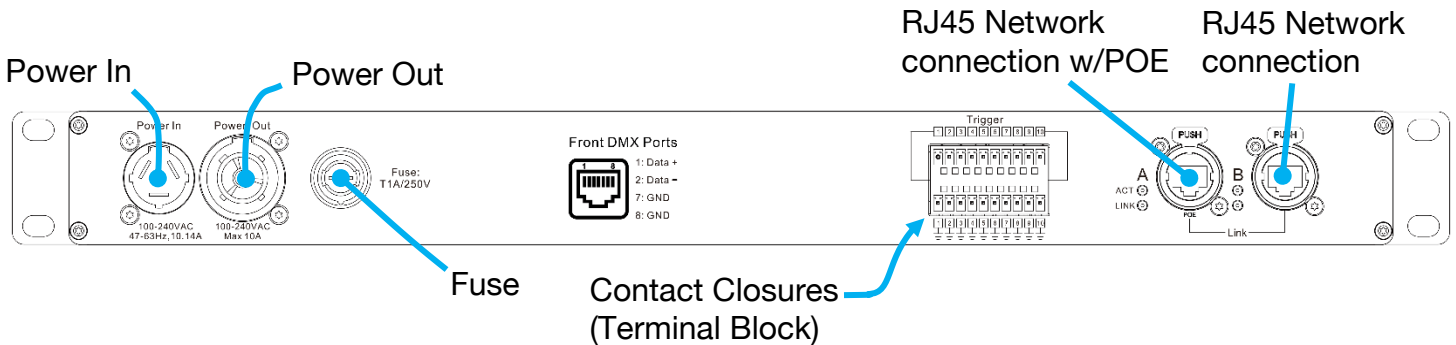

CONNECTIONS: EP4 (FRONT & REAR PANELS)

FRONT CONNECTIONS

- (4) 5pin DMX/RDM optically isolated ports
- Ports are bidirectional for DMX In and Output

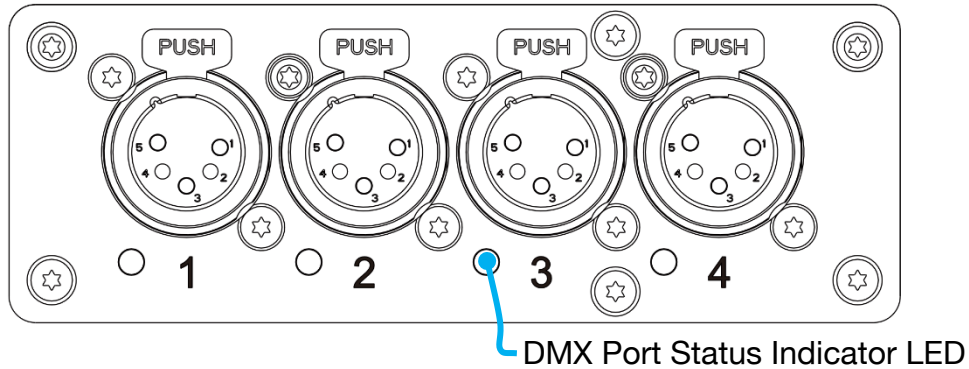

DMX PORTS STATUS INDICATOR LEDs

Ports	LED Color	Solid	Blink	Flashing/Strobing
DMX	RED	Error		
DMX	GREEN	DMX In	DMX Lost	
DMX	BLUE	DMX Out Stable	DMX Lost	
DMX	WHITE			Flash on RDM packets

The LEDs are dimmable from the System – Display menu and can be turned off completely if desired.

REAR CONNECTIONS

- USB-C power option (5V, 2A). **POWER ONLY, NO DATA CONNECTION**
- (2) Gigabit RJ45 network connections (1x POE)

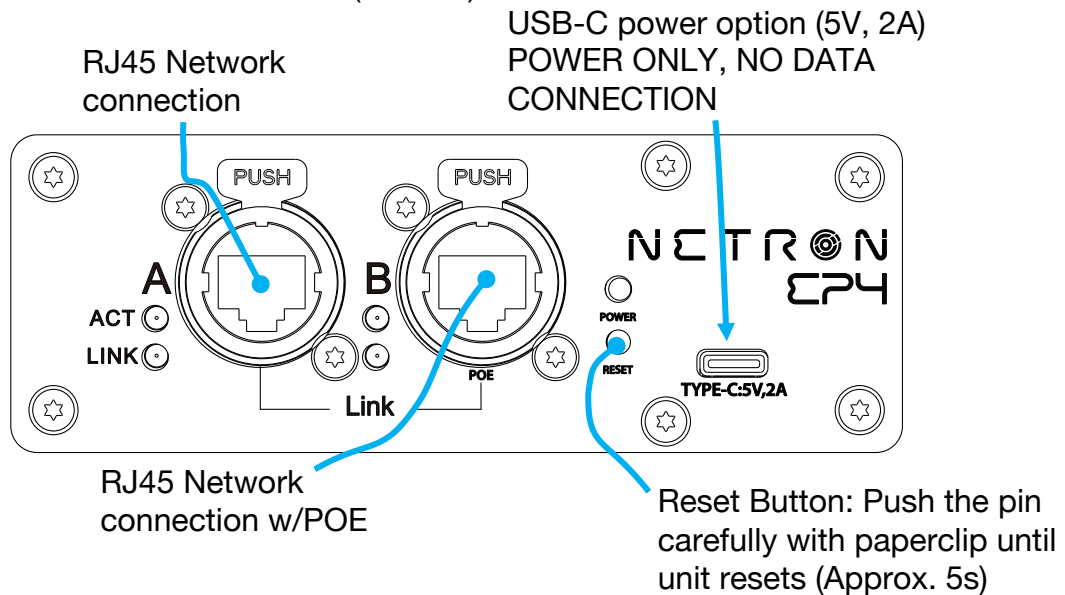

MENU: NAVIGATION

The Neutron devices use a small OLED display for feedback and setup. The encoder dials up and down through the menu, a push of the encoder selects an item or saves an entry. Revert to a previous menu or cancel an entry with a single push of the back arrow.

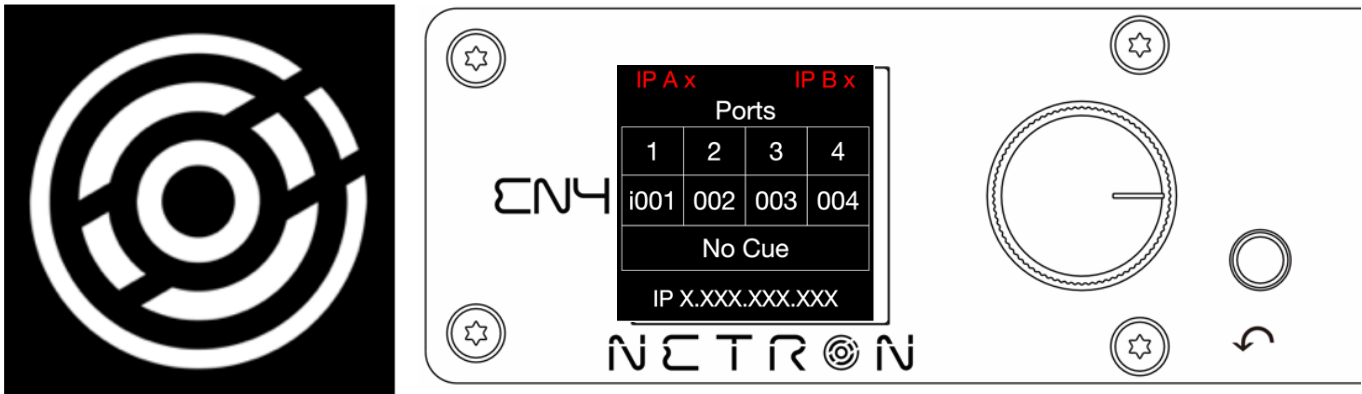

Wheel Right	Scroll down in menu list / increase values
Wheel Left	Scroll up in menu list / decrease values
Wheel Push	Enter Menu, Select menu item, go down one level in menu, confirm values.
Back Arrow	Go up one level in menu tree, cancel change of values, hold for 2 seconds to return to home screen

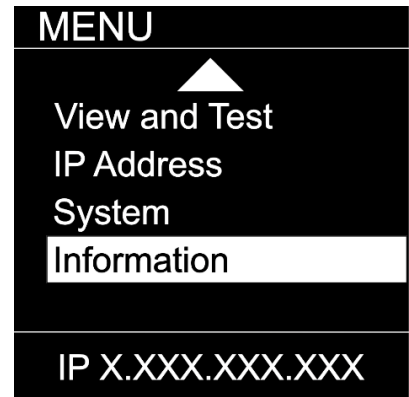
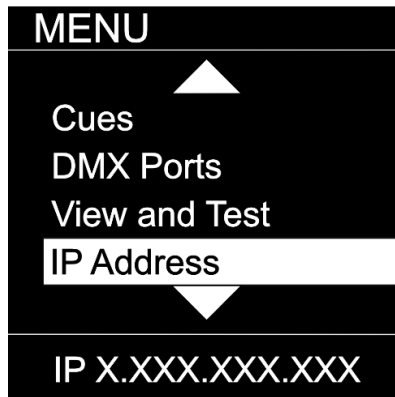
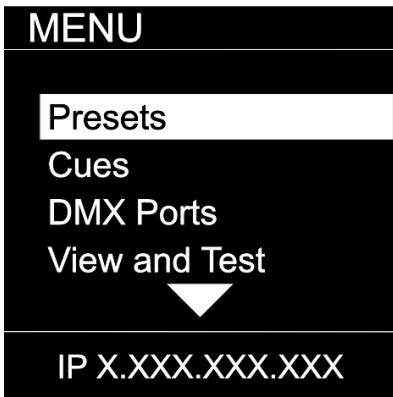

As you scroll up or down the menu, the arrows indicate that more items are available above or below that which is displayed, and only show when needed.

MENU: HOME SCREEN

This is the default screen providing quick status feedback and indicates IP and DMX traffic.

IP A / B: White text with a check mark indicates if a network port is connected. Red indicated the port is not connected.

This Device Label is configured by user, with the **Node 15** shown strictly as an example of a user defined label: the numbers shown correlate with their assigned Universe below in the Universe Box, which itself is colored following the LED feedback.

IP Address: shows the current IP address of the device. Use this address inside a web browser for remote access.

Universe Box:
 Green = DMX In
 Blue = DMX Out
 White = RDM Traffic
 Red = Error
 i005 = DMX Input Universe 5
 Purple v201 = sent value 201

Universe Box:
 Red Outline = Signal Lost

IP A x IP B x

Node 15

1	2	3	4
i001	002	003	004

No Cue

IP X.XXX.XXX.XXX

IP A ✓ IP B ✓

Node 15

1	2	3	4
i005	005	X	v201

No Cue

IP X.XXX.XXX.XXX

IP A ✓ IP B ✓

Node 15

1	2	3	4
001	002	003	004

No Cue

IP X.XXX.XXX.XXX

MENU: PRESETS

Several simple presets are preprogrammed into the device for fast setup. Some presets require additional input like a start Universe.

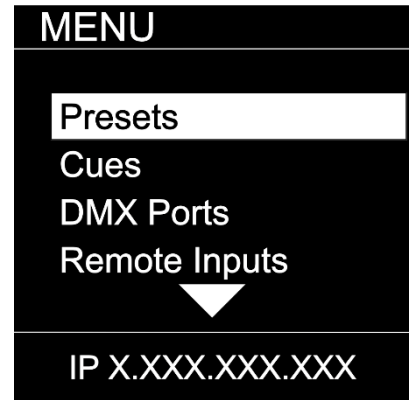

SUB MENU	OPTION / VALUES		DESCRIPTION	
MENU NETRON Presets USER PRESETS IP X.XXX.XXX.XXX	1 :ArtNet 2.x	Universe 1 – 32767	See NETRON Presets	
	2 :ArtNet 10.x	Universe 1 – 32767		
	3 :ArtNet 192.x	Universe 1 – 32767		
	4. ArtNet 172.x	Universe 1 – 32767		
	5. ArtNet DHCP	Universe 1 – 32767		
	6. ArtNet In	Universe 1 – 32767		
	7. :ArtNet In/Thru	Universe 1 – 32767		
	8. sCAN 2.x	Universe 1 – 32767		
	9. sCAN 10.x	Universe 1 – 32767		
	10. sACN 192.x	Universe 1 – 32767		
	11. :sACN 172.x	Universe 1 – 32767		
	12. sACN DHCP	Universe 1 – 32767		
	13. sACN DHCP In	Universe 1 – 32767		
	14. :Splitter Port1			
MENU NETRON Presets USER PRESETS IP X.XXX.XXX.XXX		Save Preset	Preset Saved	
		Load Preset	Preset Loaded	
	1 :MyPreset 1			
	...			
	10 :MyPreset 10	Rename Preset	12 Character Label	

MENU: NETRON PRESETS

These simple presets are preprogrammed into the device for fast setup. Some presets require additional input like a start Universe. Note that DMX Ports 1-12 apply to model EN12, and that greyed DMX Ports 1-4 apply to EN4/EP4 models.

Label	Ethernet			Protocol	Option	DMX Ports											
	IP Address	Subnet				1	2	3	4	5	6	7	8	9	10	11	12
Artnet 2.x	Automatic 2.x	255.0.0.0	Artnet	Universe #	Output	Output	Output	Output	Output	Output	Output	Output	Output	Output	Output		
				X	X	X+1	X+2	X+3	X+4	X+5	X+6	X+7	X+9	X+10	X+11	X+12	
			RDM		Yes	Yes	Yes	Yes	Yes	Yes	Yes	Yes	Yes	Yes	Yes	Yes	
Artnet 10.x	Automatic 10.x	255.0.0.0	Artnet	Universe #	Output	Output	Output	Output	Output	Output	Output	Output	Output	Output	Output		
				X	X	X+1	X+2	X+3	X+4	X+5	X+6	X+7	X+9	X+10	X+11	X+12	
			RDM		Yes	Yes	Yes	Yes	Yes	Yes	Yes	Yes	Yes	Yes	Yes	Yes	
Artnet 192.x	Automatic 192.x	255.0.0.0	Artnet	Universe #	Output	Output	Output	Output	Output	Output	Output	Output	Output	Output	Output		
				X	X	X+1	X+2	X+3	X+4	X+5	X+6	X+7	X+9	X+10	X+11	X+12	
			RDM		Yes	Yes	Yes	Yes	Yes	Yes	Yes	Yes	Yes	Yes	Yes	Yes	
Artnet 172.x	Automatic 172.x	255.0.0.0	Artnet	Universe #	Output	Output	Output	Output	Output	Output	Output	Output	Output	Output	Output		
				X	X	X+1	X+2	X+3	X+4	X+5	X+6	X+7	X+9	X+10	X+11	X+12	
			RDM		Yes	Yes	Yes	Yes	Yes	Yes	Yes	Yes	Yes	Yes	Yes	Yes	
Artnet DHCP	DHCP	DHCP	Artnet	Universe #	Output	Output	Output	Output	Output	Output	Output	Output	Output	Output	Output		
				X	X	X+1	X+2	X+3	X+4	X+5	X+6	X+7	X+9	X+10	X+11	X+12	
			RDM		Yes	Yes	Yes	Yes	Yes	Yes	Yes	Yes	Yes	Yes	Yes	Yes	
Artnet In	Automatic 2.x	255.0.0.0	Artnet	Universe #	Input	Input	Input	Input	Input	Input	Input	Input	Input	Input	Input		
				X	X	X+1	X+2	X+3	X+4	X+5	X+6	X+7	X+9	X+10	X+11	X+12	
Artnet In / Thru	Automatic 2.x	255.0.0.0	Artnet	Universe #	Input	Input	Input	Input	Input	Input	Output	Output	Output	Output	Output		
				X	X	X+1	X+2	X+3	X+4	X+5	Clone 1	Clone 2	Clone 3	Clone 4	Clone 5	Clone 6	
sACN 2.x	Automatic 2.x	255.0.0.0	sACN	Universe #	Output	Output	Output	Output	Output	Output	Output	Output	Output	Output	Output		
				X	X	X+1	X+2	X+3	X+4	X+5	X+6	X+7	X+9	X+10	X+11	X+12	
			RDM	not supported													
sACN 10.x	Automatic 10.x	255.0.0.0	sACN	Universe #	Output	Output	Output	Output	Output	Output	Output	Output	Output	Output	Output		
				X	X	X+1	X+2	X+3	X+4	X+5	X+6	X+7	X+9	X+10	X+11	X+12	
			RDM	not supported													
sACN 192.x	Automatic 192.x	255.0.0.0	sACN	Universe #	Output	Output	Output	Output	Output	Output	Output	Output	Output	Output	Output		
				X	X	X+1	X+2	X+3	X+4	X+5	X+6	X+7	X+9	X+10	X+11	X+12	
			RDM	not supported													
sACN 172.x	Automatic 172.x	255.0.0.0	sACN	Universe #	Output	Output	Output	Output	Output	Output	Output	Output	Output	Output	Output		
				X	X	X+1	X+2	X+3	X+4	X+5	X+6	X+7	X+9	X+10	X+11	X+12	
			RDM	not supported													
sACN DHCP	DHCP	DHCP	sACN	Universe #	Output	Output	Output	Output	Output	Output	Output	Output	Output	Output	Output		
				X	X	X+1	X+2	X+3	X+4	X+5	X+6	X+7	X+9	X+10	X+11	X+12	
			RDM	not supported													
sACN DHCP In	DHCP	DHCP	sACN	Universe #	Input	Input	Input	Input	Input	Input	Input	Input	Input	Input	Input		
				X	X	X+1	X+2	X+3	X+4	X+5	X+6	X+7	X+9	X+10	X+11	X+12	
Splitter Port 1	Automatic 2.x	255.0.0.0	Artnet		Input	Output	Output	Output	Output	Output	Output	Output	Output	Output	Output		
				X	X	Clone 1	Clone 1	Clone 1	Clone 1	Clone 1	Clone 1	Clone 1	Clone 1	Clone 1	Clone 1	Clone 1	

MENU: CUES

A cue is a full static snapshot of all DMX values of all ports. The device supports 99 cues with fade and hold times, plus a link option to loop multiple cues together. This allows small “mini” cuelists to be created. Cues are used for standalone operation, as a backup for signal loss or can be assigned to one of the switch inputs. This is often used for fire alarm situations where a system has to go to a defined state and stop all console playback. Cues can be sent as Ethernet Universes so one device can drive many other Netron nodes.

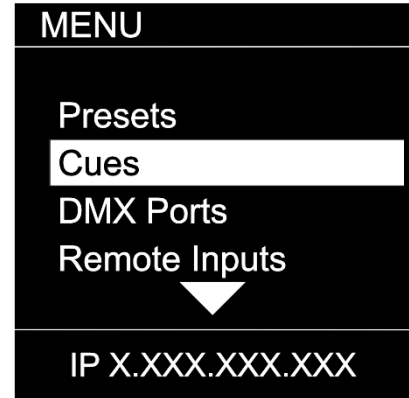

SUB MENU		OPTIONS / VALUES		DESCRIPTION
MENU	Run Cue	1 – 99	Go/Off	Select the desired cue
	Run Cue Save Cues Rename Cue Link Cues ▼	Save Cue	1:Cue 1 ... 99:Cue 99 Save Cue? Yes/No	Save all values on all ports to a cue slot
IP X.XXX.XXX.XXX	Rename Cue	1 – 99	12 Character Label	Edit name of cue
MENU ▲ Save Cues Rename Cue Link Cues Resend Ethernet IP X.XXX.XXX.XXX	Link Cues	1 – 99	Fade Time 0s – 99.59min	Set the fade time of the cue
			Hold Time 0s – 99.59min	Set the time to hold the cue until the next cue is started
		Link to Cue	Disable, 1 – 99	Set the next Cue
Resend Ethernet	Resend Ethernet	Enable	Disable	Cue data is not sent over Ethernet
			Enable	Cue data is sent on the Universe number and protocol assigned to the ports.

MENU: DMX PORTS

Select a port number to adjust its settings. Depending on the Mode, certain options are not relevant and hidden from the display or web interface.

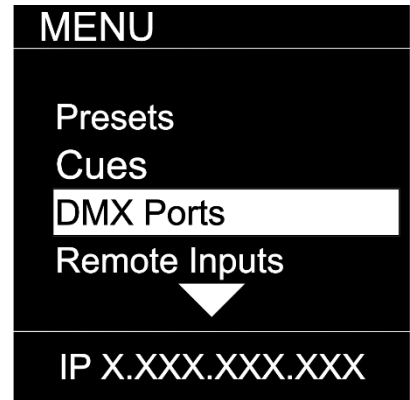

SUB MENU	OPTIONS / VALUES		DESCRIPTION	
MENU	Mode	Disable	The port is disabled.	
		Input	The port receives DMX values and assigns them to the selected Universe.	
		Output	The port sends out DMX Values on the selected Universe	
		Send Value	0 – 255	Send a static DMX value
	Universe	1 – 32767	Select the EtherDMX Universe	
	Protocol	Art-Net, sACN, None	Select the EtherDMX protocol per port	
	FrameRate	10, 15, 20, 25, 30, 35 , 40	Select the desired frame rate.	
	RDM	Disable, Enable	Disable / Enable RDM traffic for this port	
	Merge	OFF		The merger is disabled
		HTP		The sources are merged by Highest Takes Precedence
LTP			The sources are merged by Last Takes Precedence	
Toggle			The complete source Universe is switched as soon as a single value changes	
Backup			The merge universe is activated if the main universe has no valid traffic	
Clone	None , Port 2, Port 3, Port 4	Replicates the identical DMX data from another port		
Range	From: 1 – 512		To limit the DMX range, set the first address of the DMX port	
	To: 1 – 512		To limit the DMX range, set the last address of the DMX port	
	Offset Addr	Off, 2 - 511	Offset start address, incoming channel X value is sent on this port as channel X+Offset, Channels are cut off if they exceed 512	
Port 1				
Port 2				
Port 3				
Port 4				
IP X.XXX.XXX.XXX				

MENU: REMOTE INPUT

The device supports ten remote assignments that can trigger specific actions like recalling a cue or preset. These events are recalled using local contact closures, DMX In, or a specific EtherDMX Universe / Address.

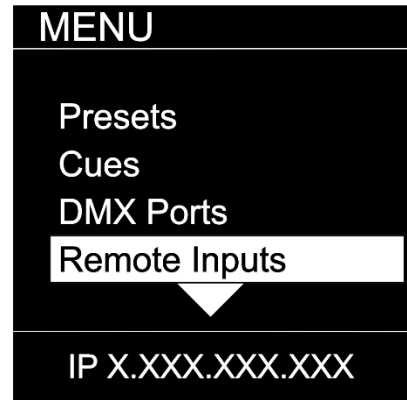

SUB MENU	OPTIONS / VALUES		DESCRIPTION	
MENU Input 1 Input 2 Input 3 Input 4 ▼ IP X.XXX.XXX.XXX	Cue	1 – 99	Recall a specific cue number	
	Cue Mode	Trigger	The cue is activated, and all times and links are processed even if the contact is opened again	
		Toggle	The cue is activated, and all times and links are processed only if the contact is closed. Once toggle is opened, device will assume DMX traffic or No DMX status. This allows to alternate between two cues for example with the toggle switch.	
MENU Input 1 Input 2 Input 3 Input 4 ▼ IP X.XXX.XXX.XXX	Netron Preset	a,b,c,...	Recalls this Netron preset when the contact is closed	
	User Preset	1 – 10	Recalls this user preset when contact is closed	
MENU Input 1 Input 2 Input 3 Input 4 ▼ IP X.XXX.XXX.XXX	Disable DMX		Stops all DMX output for as long as contact is closed	
	Send Value	0 – 255	Sends specific DMX value on all ports for as long as contact is closed	
	Source	disabled		Input is disabled
		DMX Port	1 – xx	Use DMX Port. Port must be set as Input
		Art-Net		Art-Net Trigger
		sACN		sACN Trigger
		Universe		Set Universe for remote trigger
Address		Set DMX Address for remote trigger		

DMX Map for Remote Trigger

Inputs can be remotely activated over DMX, Art-Net, or sACN. The input is activated if the DMX value is at the value shown below.

Value	Action
0 – 10	Idle
11 – 20	Input 1
21 – 30	Input 2
31 – 40	Input 3
41 – 50	Input 4
51 – 60	Input 5
61 – 70	Input 6
71 – 80	Input 7
81 – 90	Input 8
91 – 100	Input 9
101 – 110	Input 10
111 – 255	Idle

MENU: VIEW AND TEST

This Neutron device provides a variety of tools right from the front display to monitor and test the system. Colors indicate changing values.

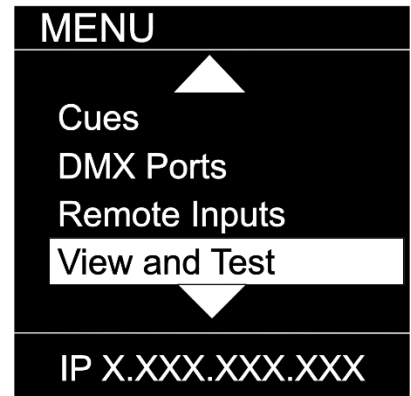

SUB MENU		OPTIONS / VALUE		Description
MENU DMX View Art-Net View sACN View DMX Port Test IP X.XXX.XXX.XXX	DMX View	View	Port 1 – 4	View the DMX values of a specific port
		Range	From: 1 – 512	default 1
			To: 1 – 512	default 512
	Start Monitor		Start Monitoring Values. Use Encoder to dial to the desired DMX address. Push Encoder to change display readout style (Grid, List, Address)	
	Art-Net View	Universe	1 – 32767	View a specific Art-Net Universe
		Range	From: 1 – 512	default 1
			To: 1 – 512	default 512
	Start Monitor		Start Monitoring Values. Use Encoder to dial to the desired DMX address. Push Encoder to change display readout style (Grid, List, Address)	
	sACN View	Universe	1 – 32767	View a specific sACN Universe
Range		From: 1 – 512	default 1	
		To: 1 – 512	default 512	
Start Monitor		Start Monitoring Values. Use Encoder to dial to the desired DMX address. Push Encoder to change display readout style (Grid, List, Address)		
MENU sACN View DMX Port Test Art-Net Test sACN Test IP X.XXX.XXX.XXX	DMX Port Test	Output	Port 1 – 4	Send generator values on specific port
			All Ports	Send generator values on all ports
		Range	From: 1 – 512	default 1
		To: 1 – 512	default 512	
	Speed	1 – 10, Manual	Select the speed of generator	
	Art-Net Test	Universe	1 – 32767	Select Art-Net Universe
		Range	From: 1 – 512	default 1
			To: 1 – 512	default 512
	Speed	1 – 10, Manual	Select the speed of generator	
sACN Test	Universe	1 – 32767	Select sACN Universe	
	Range	From: 1 – 512	default 1	
		To: 1 – 512	default 512	
Speed	1 – 10, Manual	Select the speed of generator		

MENU: VIEW AND TEST (continued)

Monitor (DMX View, Art-Net View, sACN View)

The monitoring options are helpful to find faults, or simply watch incoming traffic. Three styles are available by clicking the encoder wheel. Dial the wheel to change the display to the desired address, and exit the monitor with the back button.

DMX Test Display – Grid

The color coding helps to quickly identify changing DMX values.

- Cyan: DMX Address
- Green: Value Decreased
- Red: Value Increased
- White: Value stable (after 10 seconds)

DMX View Address 1-20					
1	0	0	0	56	12
6	1	255	255	128	60
11	123	231	5	55	88
16	12	67	255	255	98
IP X.XXX.XXX.XXX					

DMX View Address 8-28					
8	0	0	0	56	12
13	1	255	255	128	60
18	123	231	5	55	88
24	12	67	255	255	98
IP X.XXX.XXX.XXX					

DMX View Address 8-28					
501	0	0	0	56	12
506	1	255	255	128	60
511	123	0			
IP X.XXX.XXX.XXX					

DMX Test Display – Line

DMX View Address 1-5			
		Min	Max
1	0	0	12
2	1	0	60
3	121	5	123
4	12	98	255
5	88	8	88
IP X.XXX.XXX.XXX			

DMX Test Display – Address

DMX View	
Address	Value
1	127
	50%
Min	0
Max	255
IP X.XXX.XXX.XXX	

MENU: IP ADDRESS

Set the desired device IP address in this menu. Every Netron device is set to a unique 2.x.x.x address at the factory, and after every reset to this default. For Art-Net systems, it should never be necessary to adjust this IP. Any custom address and subnet can be assigned so the node can operate within any network environment. EP4 devices default to 2.0.0.1 as they contain no display. Configure each EP4 to a unique IP using the web remote access.

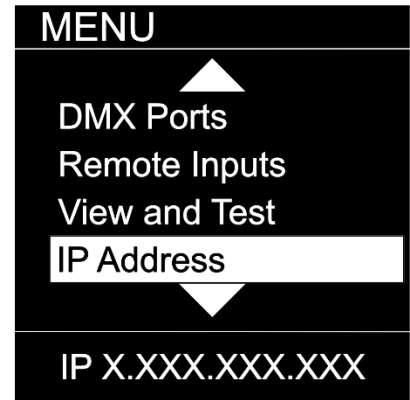

SUB MENU		OPTIONS / VALUES		Description	
MENU DHCP IP Automatic 2.X Automatic 10.x Custom IP IP X.XXX.XXX.XXX	DHCP IP			The device waits for a DHCP server address After 30s it assigns itself a unique 169.254.x.x address but continues to monitor DHCP server requests.	
	Automatic 2.x			The device is set to a unique 2.x.x.x Address, Subnet 255.0.0.0	
	Automatic 10.x.x			The device is set to a unique 10.x.x.x Address, Subnet 255.0.0.0	
	Custom IP	IP Address	x.x.x.x		Assign any desired numbers. The device does not check the validity of address and subnet values.
		Subnet Mask	x.x.x.x		
	Automatic 192.x			The device is set to a unique 192.x.x.x Address, Subnet 255.0.0.0	
	Automatic 172.x			The device is set to a unique 172.x.x.x Address, Subnet 255.0.0.0	

MENU: SYSTEM

This menu contains all the settings to configure and manage the device.

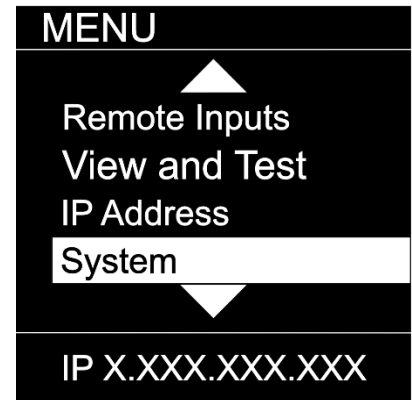

SUB MENU		OPTIONS / VALUES		Description	
	Device Name	12 Character Label		Set a device name	
	Device ID	0 – 999		Set an optional device ID	
MENU Device Name Device ID Display ArtNet Start IP X.XXX.XXX.XXX	Display	Display Timeout	Disable 10s, 30s, 1m, 5m, 10m	Display stays on indefinitely Display goes dark after this time	
		Screen Brightness	1-10	Adjust the brightness of the internal display	
		LED Brightness	0-10	Adjust the brightness of the front LEDs. Set to 0 to disable them.	
		Home Screen	Device Info	The display shows port and connectivity information	
			Cue Browser	The display shows a list of stored cues which can easily be browsed and started by the encoder wheel	
ArtNet Start	Universe 0 Universe 1		Universe 1 is sent to Art-Net 0-0 Universe 1 is sent to Art-Net 0-1		
MENU Lock Device Startup Signal Loss Backup Config IP X.XXX.XXX.XXX	Lock Device	PIN: 000 (011)	Lock	Disable Timeout	The device does not require a pin The device asks for a pin after the display times out
			Manual Lock: 000 (011)	Lock / Unlock	Lock the device immediately
		Startup	Cue		
Wait for Data				No DMX is sent until valid data is received for the ports. The last incoming values continue to be sent on the ports until the time is expired. Once timeout has completed the device will perform one of the below actions	
Send 0					
MENU Signal Loss Backup Config RDM Processing Factory Reset IP X.XXX.XXX.XXX	Signal Loss	Hold Last Look	Forever, 0s, 10s, 30s, 1m, 5m, 10m, 60m	The last incoming values continue to be sent on the ports until the time is expired. Once timeout has completed the device will perform one of the below actions.	
		Fade to 0	0-60s (30s)	Crossfade to DMX 0. Set to 0s for instant out.	
		Cue	No Cue	Start Cue X	
		Disable DMX		DMX traffic is turned off on all ports	
Backup Config	Save Config	Config Saved		Save current configuration including all cue data	
	Load Config	Config Loaded		Reload configuration. Backups can be exported and imported from the web interface	
RDM Processing	All Disable			Disables RDM processing on the device	
	All Enable			Enables all RDM processing on the device	
Factory Reset	Pin: 000 (011)	Confirm	Device will be reset to factory defaults. Yes/No	Reset the device to factory default. It will reload NETRON Preset 1. All cues are deleted, and all settings are set to default.	
	Pin: 000 (007)	Confirm	Device will be reset to User Preset 1. Yes/No	Reset the device to User Preset 1.	

MENU: INFORMATION

This menu provides information about the device.

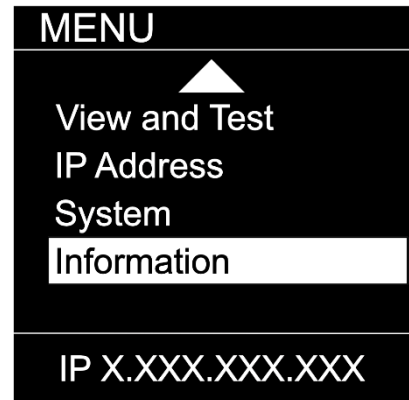

SUB MENU		OPTIONS / VALUES	DESCRIPTION
	Software Version	Boot SW V# Firmware: V#	Display the current software version
MENU			
Software Version Product On Time MAC Address RDM UID	Product On Time	Time: XXXXX(H)	Total time the device has been powered on.
IP X.XXX.XXX.XXX	MAC Address	x:x:x:x:x:x	Displays MAC address
	RDM UID	UID1: xxxx	Displays product RDM UID.

WEB REMOTE CONFIGURATION

Ensure the device and a computer are do not share IP address, but are in the same IP address range and connected.

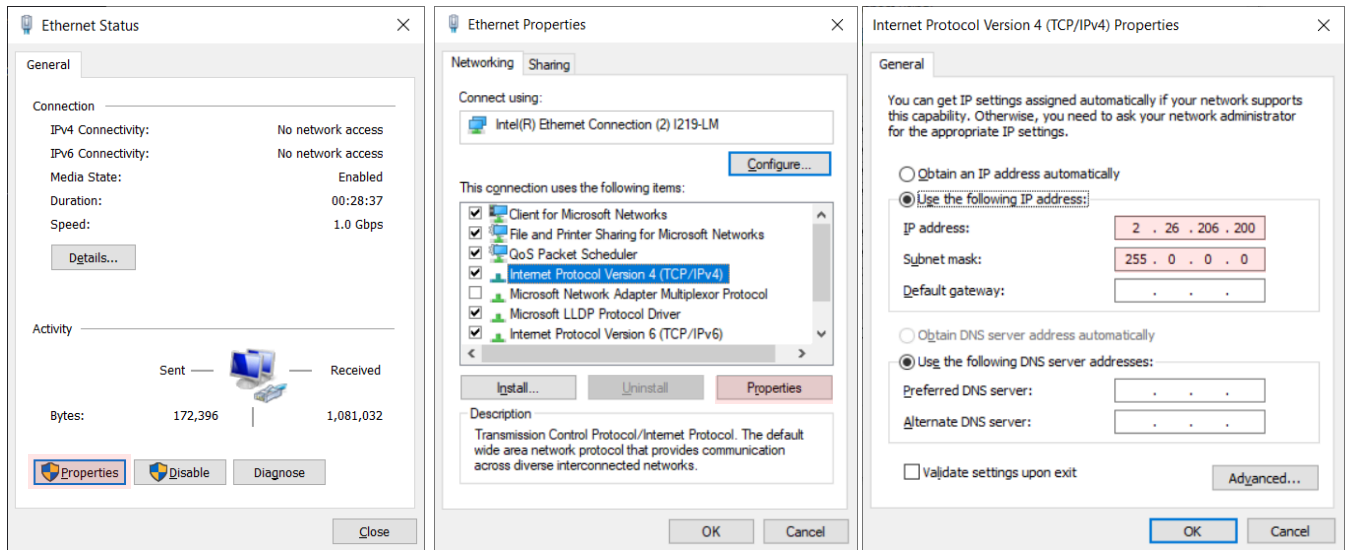

PC Configuration Sample: Please note your PC configuration results may vary.

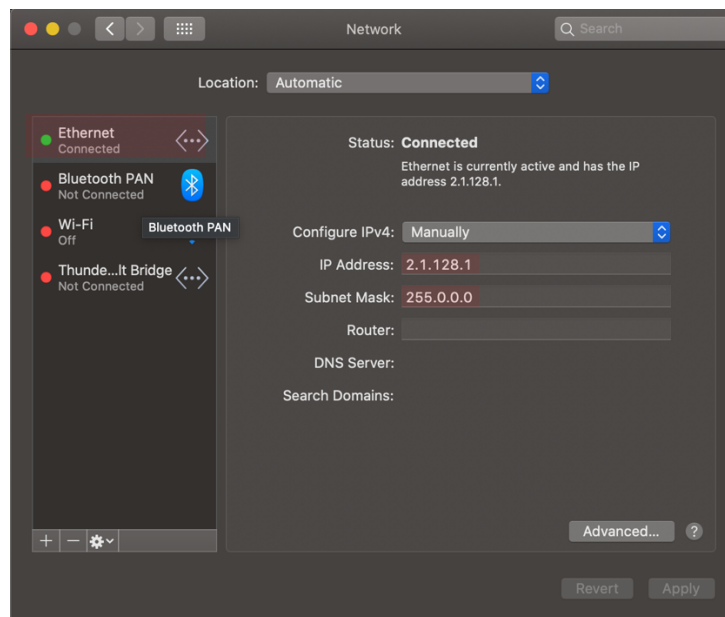

MAC OS Configuration Sample: Please note your MAC OS configuration results may vary.

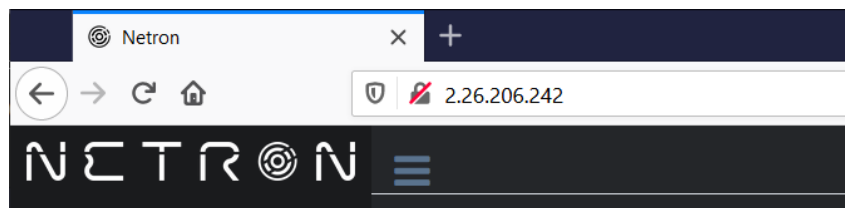

Browser Sample: Enter the device IP address into a web browser to access the device page.

WEB REMOTE MENU: HOMEPAGE

Please note that Netron devices are not compatible with Microsoft Internet Explorer. Also, the antivirus software AVAST is known to block important communication with NETRON, and must be disabled for the web interface and firmware updates to function.

The screenshot shows a web browser with two tabs: 'NETRON EN4' (IP: 2.188.56.6) and 'NETRON EN12' (IP: 2.85.24.68). The main interface displays the 'Status' page for a device. The left sidebar contains navigation options: Presets, DMX Ports, Cues, IP Settings, Inputs, and System. The main content area shows the 'Info' and 'DMX Ports' sections for the selected device.

Device Info (NETRON EN4):

Device Type	NETRON EN4
Device Name	NETRON EN4
IP Address	002.188.056.006
Net Mask	255.000.000.000

DMX Ports (NETRON EN4):

Port#	Mode	Protocol	Universe	Frame Rate	RDM	Merge
1	Output	Artnet	1	35Hz	Enable	OFF
2	Output	Artnet	2	35Hz	Enable	OFF
3	Output					
4	Output					

Device Info (NETRON EN12):

Device Type	NETRON EN12
Device Name	NETRON EN12
IP Address	002.085.024.068
Net Mask	255.000.000.000

DMX Ports (NETRON EN12):

Port#	Mode	Protocol	Universe	Frame Rate	RDM	Merge
1	Output	Artnet	1	35Hz	Enable	OFF
2	Output	Artnet	2	35Hz	Enable	OFF
3	Output	Artnet	3	35Hz	Enable	OFF
4	Output	Artnet	4	35Hz	Enable	OFF
5	Output	Artnet	5	35Hz	Enable	OFF
6	Output	Artnet	6	35Hz	Enable	OFF
7	Output	Artnet	7	35Hz	Enable	OFF
8	Output	Artnet	8	35Hz	Enable	OFF
9	Output	Artnet	9	35Hz	Enable	OFF
10	Output	Artnet	10	35Hz	Enable	OFF
11	Output	Artnet	11	35Hz	Enable	OFF
12	Output	Artnet	12	35Hz	Enable	OFF

Identify Button:

IP:002.188.056.006
Name:NETRON EN4
Identify

IP:002.188.056.006
Name:NETRON EN4
Identify

Identify Button:
Identify sets device into blinking Red/White LEDs and a blinking display to find Netron devices.

WEB REMOTE MENU: PRESETS – NETRON PRESETS

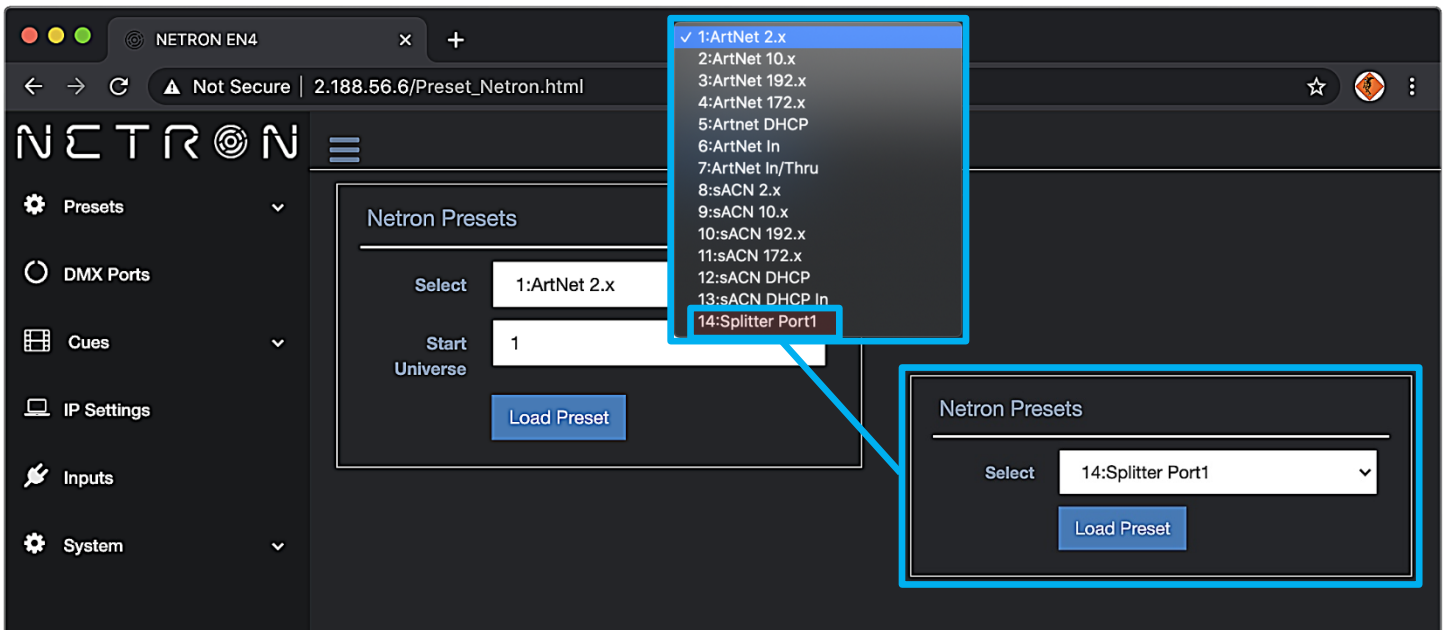

WEB REMOTE MENU: PRESETS – USER PRESETS

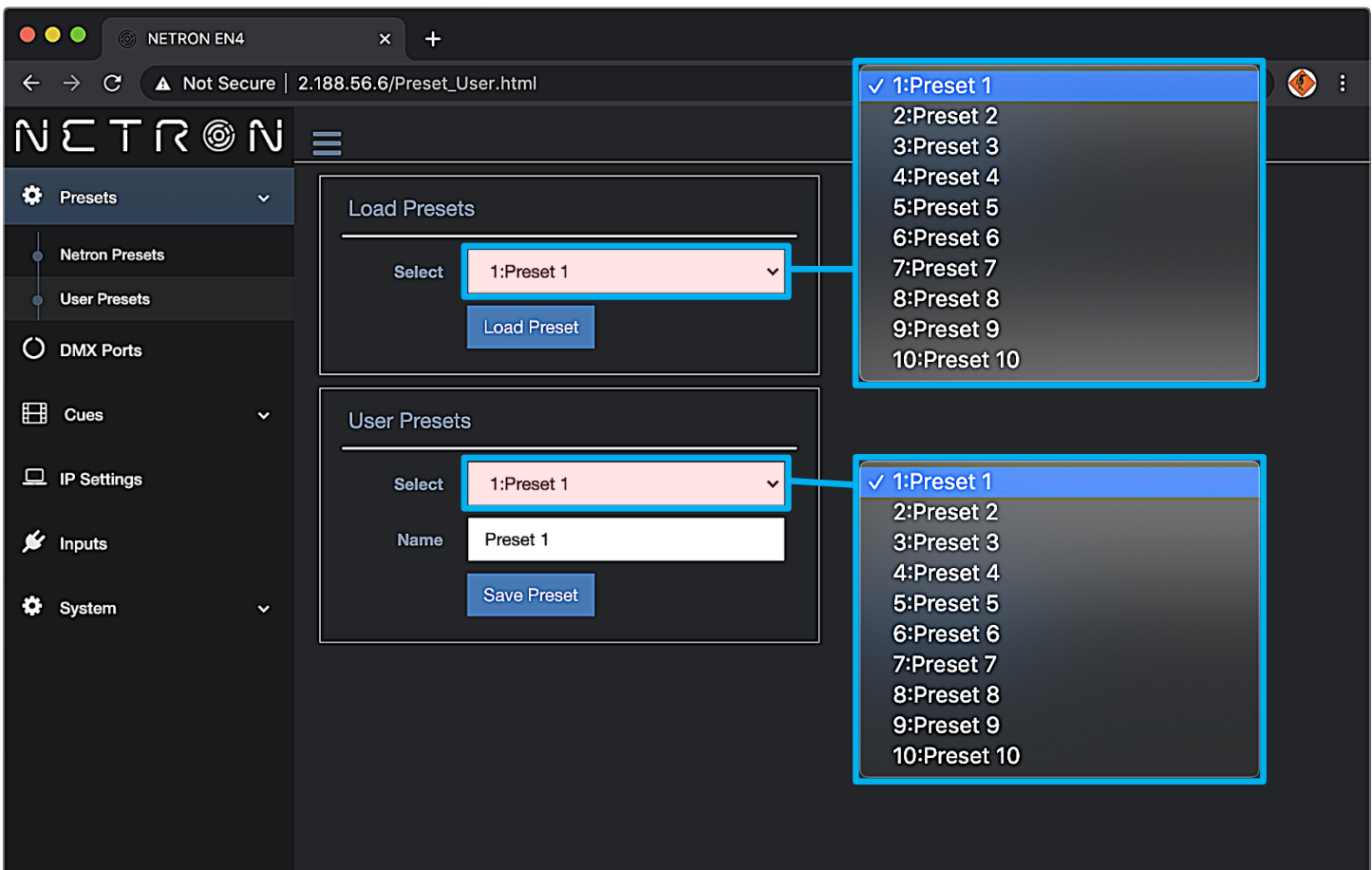

WEB REMOTE MENU: DMX PORTS – OUTPUT

NETRON EN4
Not Secure | 2.188.56.6/DMX_Ports.html

DMX Port Configuration

1 2 3 4

Mode: Output

Universe: 1

Protocol: ArtNet

Framerate: 35 Hz

RDM:

Merge: OFF

Resend Protocol: ArtNet

DMX Range From: 1

DMX Range To: 512

Offset Address: 1

Clone Port: None

Save

Mode Menu: Disable, Input, **Output**, Send Value

Protocol Menu: **ArtNet**, sACN, None

Framerate Menu: 10 Hz, 15 Hz, 20 Hz, 25 Hz, 30 Hz, **35 Hz**, 40 Hz

Merge Menu: **OFF**, HTP, LTP, Toggle, Backup

Resend Protocol Menu: **ArtNet**, sACN, None

Clone Port Menu: **None**, Port 2, Port 3, Port 4

Merge: HTP

Merge Universe: 5

Resend Protocol: ArtNet

Resend Merge Universe: 9

DMX Range From: 1

DMX Range To: 512

Offset Address: 1

Clone Port: None

Save

Merge Menu: **OFF**, HTP, LTP, Toggle, Backup

Resend Protocol Menu: **ArtNet**, sACN, None

Clone Port Menu: **None**, Port 2, Port 3, Port 4

WEB REMOTE MENU: DMX PORTS – DISABLE

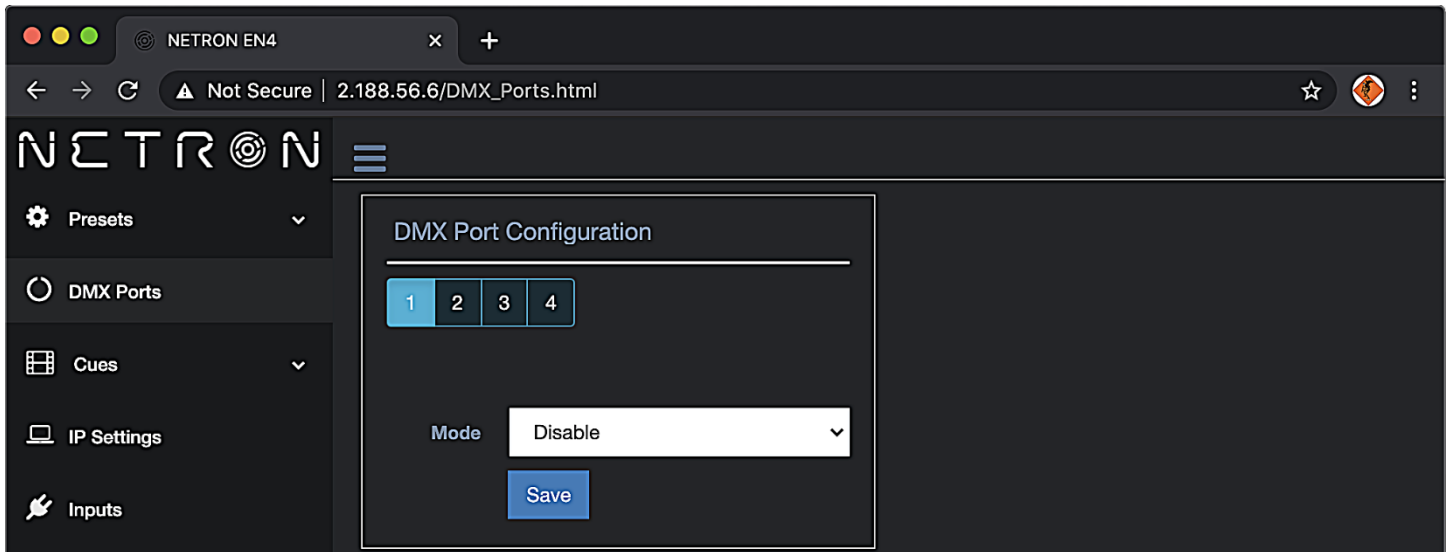

WEB REMOTE MENU: DMX PORTS – INPUT

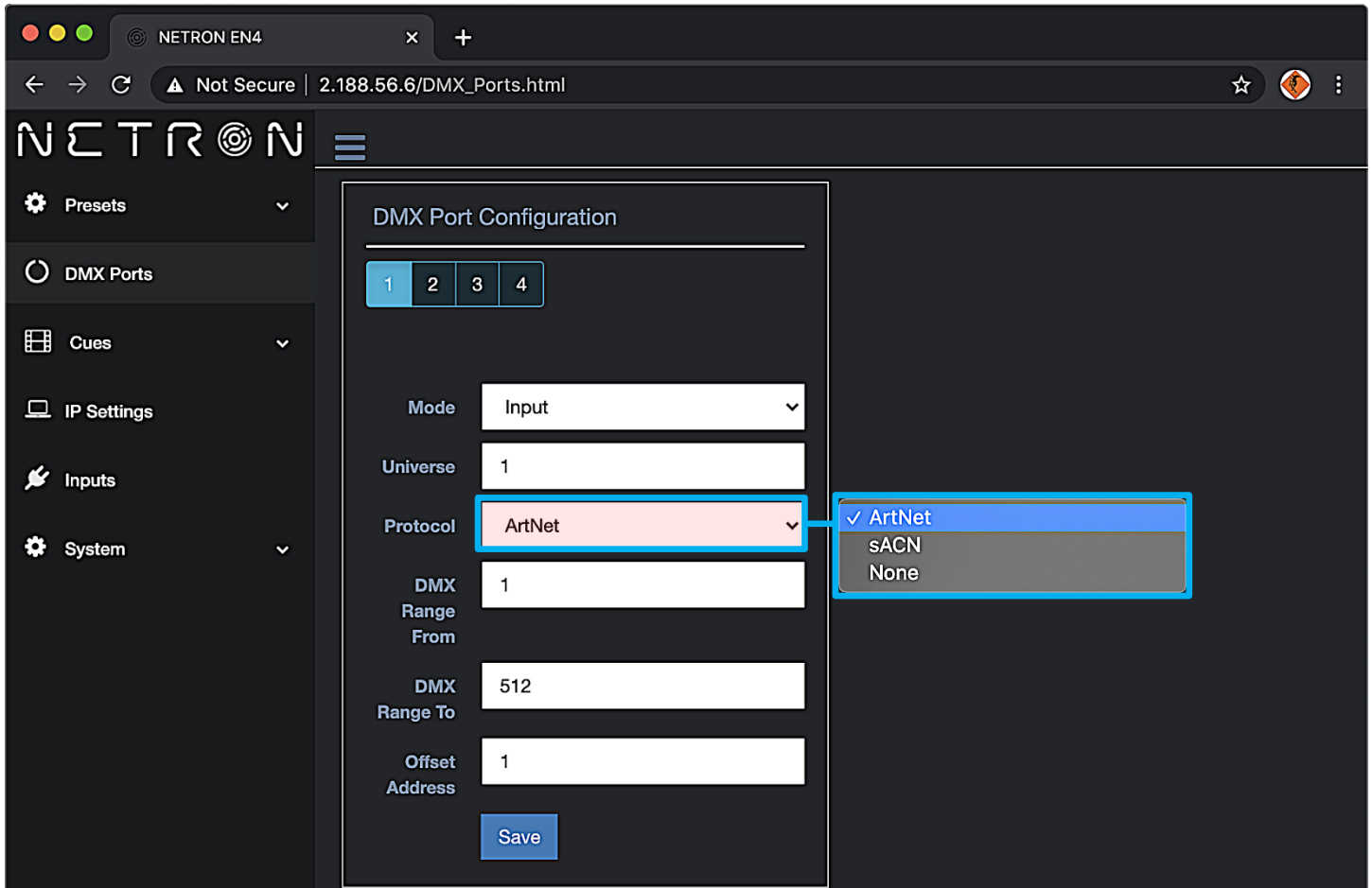

WEB REMOTE MENU: DMX PORTS – SEND VALUE

The screenshot shows the NETRON EN4 web interface for configuring DMX ports. The browser address bar shows the URL `2.188.56.6/DMX_Ports.html`. The left sidebar contains navigation options: Presets, DMX Ports, Cues, IP Settings, Inputs, and System. The main content area is titled "DMX Port Configuration" and features a tabbed interface with tabs for ports 1, 2, 3, and 4. Port 1 is currently selected.

The configuration for port 1 includes the following fields:

- Mode:** Send Value
- Send Value:** 0
- Framerate:** 35 Hz (highlighted in a blue box)
- DMX Range From:** 1
- DMX Range To:** 512

A dropdown menu for the "Framerate" field is open, displaying a list of options: 10 Hz, 15 Hz, 20 Hz, 25 Hz, 30 Hz, 35 Hz (checked and highlighted in a blue box), and 40 Hz. A "Save" button is located at the bottom of the configuration panel.

At the bottom left of the interface, the following information is displayed:

- IP:002.188.056.006
- Name:NETRON EN4
- Identify

WEB REMOTE MENU: CUES – RUN CUES

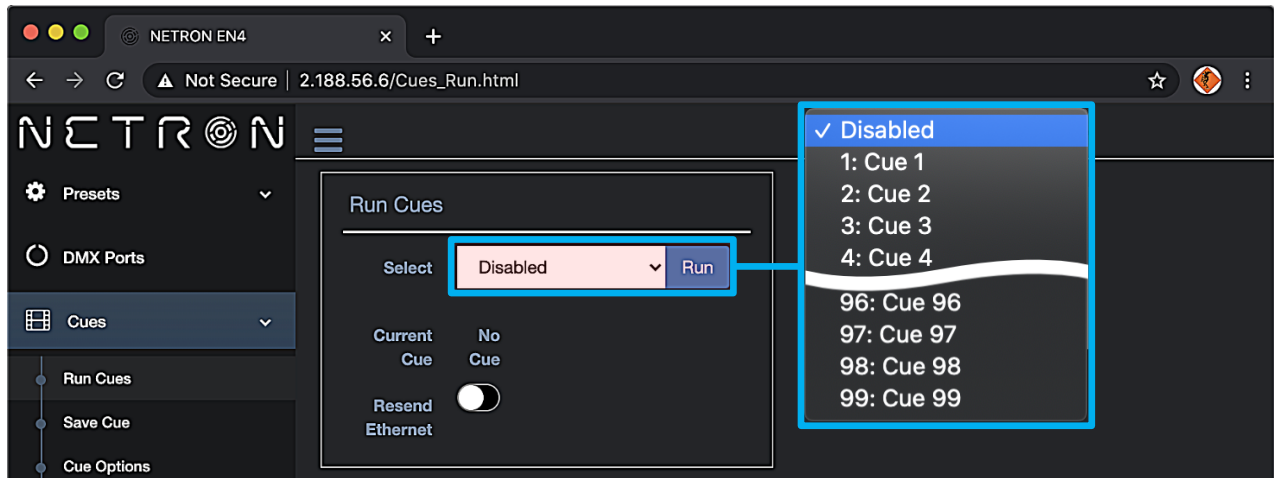

WEB REMOTE MENU: CUES – SAVE CUES

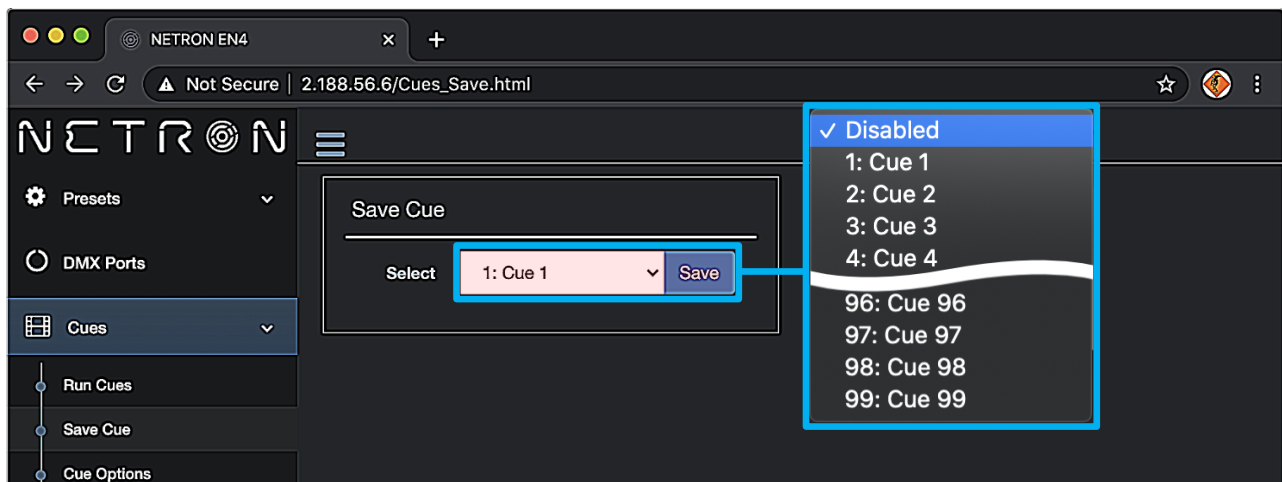

WEB REMOTE MENU: CUES – CUE OPTIONS

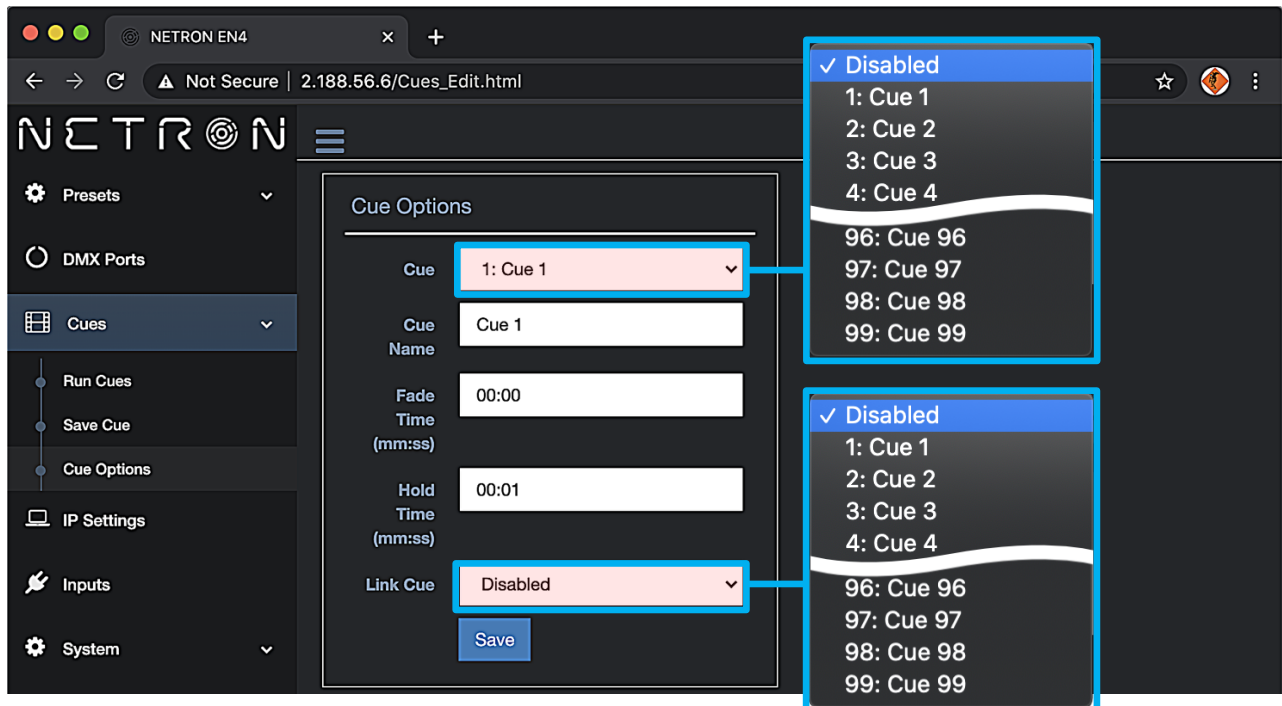

WEB REMOTE MENU: IP SETTINGS

The screenshot shows the NETRON EN4 web interface. The browser address bar displays "Not Secure | 2.188.56.6/IP.html". The left sidebar contains navigation options: Presets, DMX Ports, Cues, IP Settings (selected), Inputs, and System. The main content area is titled "IP Address" and contains the following fields:

- Address Mode:** A dropdown menu currently showing "Automatic 2.x.x.x". A blue box highlights this dropdown, and a callout menu is open to its right.
- IP:** A text input field containing "002.188.056.006".
- Subnet:** A text input field containing "255.000.000.000".

Below the input fields are "Save" and "Cancel" buttons. The callout menu for the "Address Mode" dropdown lists the following options:

- DHCP IP
- ✓ Automatic 2.x.x.x (highlighted)
- Automatic 10.x.x.x
- Custom IP
- Automatic 192.168.x.x
- Automatic 172.168.x.x

At the bottom left of the interface, the following information is displayed:

IP:002.188.056.006
Name:NETRON EN4
Identify

WEB REMOTE MENU: INPUTS – DISABLE DMX

NETRON EN4

Not Secure | 2.188.56.6/Remotelnputs.html

NETRON

Presets

DMX Ports

Cues

IP Settings

Inputs

System

Inputs Configuration

1 2 3 4 5 6 7 8 9 10

Event Type: Disable DMX

Trigger Source: Disable

Save

Disable DMX

- Cue
- Netron Preset
- User Preset
- Send Value

Disable

- DMX Port
- ArtNet
- sACN

Inputs Configuration

1 2 3 4 5 6 7 8 9 10

Event Type: Disable DMX

Trigger Source: DMX Port

DMX Port

- Port A
- Port B
- undefined
- undefined

DMX Address

Save

Inputs Configuration

1 2 3 4 5 6 7 8 9 10

Event Type: Disable DMX

Trigger Source: ArtNet

Universe: 1

DMX Address: 1

Save

Inputs Configuration

1 2 3 4 5 6 7 8 9 10

Event Type: Disable DMX

Trigger Source: sACN

Universe: 1

DMX Address: 1

Save

WEB REMOTE MENU: INPUTS – CUE

NETRON EN4

Not Secure | 2.188.56.6/RemoteInputs.html

NETRON

Presets

DMX Ports

Cues

IP Settings

Inputs

System

Inputs Configuration

1 2 3 4 5 6 7 8 9 10

Event Type Cue

Cue Number 0:No Cue

Cue Mode Trigger

Trigger Source Disable

Save

0:No Cue

1:Cue 1

2:Cue 2

3:Cue 3

4:Cue 4

96:Cue 96

97:Cue 97

98:Cue 98

99:Cue 99

Trigger Toggle

Disable

DMX Port

ArtNet

sACN

Inputs Configuration

1 2 3 4 5 6 7 8 9 10

Event Type Cue

Cue Number 0:No Cue

Cue Mode Trigger

Trigger Source Disable

Save

Inputs Configuration

1 2 3 4 5 6 7 8 9 10

Event Type Cue

Cue Number 0:No Cue

Cue Mode Trigger

Trigger Source DMX Port

DMX Port Port 1

DMX Address 1

Save

Inputs Configuration

1 2 3 4 5 6 7 8 9 10

Event Type Cue

Cue Number 0:No Cue

Cue Mode Trigger

Trigger Source ArtNet

Universe 1

DMX Address 1

Save

Inputs Configuration

1 2 3 4 5 6 7 8 9 10

Event Type Cue

Cue Number 0:No Cue

Cue Mode Trigger

Trigger Source sACN

Universe 1

DMX Address 1

Save

WEB REMOTE MENU: INPUTS – NETRON PRESETS

NETRON EN4

Not Secure | 2.188.56.6/RemoteInputs.html

NETRON

Presets

DMX Ports

Cues

IP Settings

Inputs

System

Inputs Configuration

1 2 3 4 5 6 7 8 9 10

Event Type: Netron Preset

Netron Preset: 1:ArtNet 2.x

Trigger Source: Disable

Save

- 1:ArtNet 2.x
- 2:ArtNet 10.x
- 3:ArtNet 192.x
- 4:ArtNet 172.x
- 5:ArtNet DHCP
- 6:ArtNet In
- 7:ArtNet In/Thru
- 8:sACN 2.x
- 9:sACN 10.x
- 10:sACN 192.x
- 11:sACN 172.x
- 12:sACN DHCP
- 13:sACN DHCP In
- 14:Splitter Port1

- Disable
- DMX Port
- ArtNet
- sACN

Inputs Configuration

1 2 3 4 5 6 7 8 9 10

Event Type: Netron Preset

Netron Preset: 1:ArtNet 2.x

Trigger Source: DMX Port

DMX Port: Port A

DMX Address: undefined

Save

Inputs Configuration

1 2 3 4 5 6 7 8 9 10

Event Type: Netron Preset

Netron Preset: 1:ArtNet 2.x

Trigger Source: ArtNet

Universe: 1

DMX Address: 1

Save

Inputs Configuration

1 2 3 4 5 6 7 8 9 10

Event Type: Netron Preset

Netron Preset: 1:ArtNet 2.x

Trigger Source: sACN

Universe: 0

DMX Address: 1

Save

WEB REMOTE MENU: INPUTS – USER PRESETS

NETRON EN4

Not Secure | 2.188.56.6/Remotelnputs.html

NETRON

Presets

DMX Ports

Cues

IP Settings

Inputs

System

Inputs Configuration

1 2 3 4 5 6 7 8 9 10

Event Type: User Preset

User Preset: 1:Preset 1

Trigger Source: Disable

Save

- 1:Preset 1
- 2:Preset 2
- 3:Preset 3
- 4:Preset 4
- 5:Preset 5
- 6:Preset 6
- 7:Preset 7
- 8:Preset 8
- 9:Preset 9
- 10:Preset 10

- Disable
- DMX Port
- ArtNet
- sACN

Inputs Configuration

1 2 3 4 5 6 7 8 9 10

Event Type: User Preset

User Preset: 1:Preset 1

Trigger Source: DMX Port

DMX Port: Port A, Port B, undefined, undefined

DMX Address: undefined, undefined

Save

Inputs Configuration

1 2 3 4 5 6 7 8 9 10

Event Type: User Preset

User Preset: 1:Preset 1

Trigger Source: ArtNet

Universe: 1

DMX Address: 1

Save

Inputs Configuration

1 2 3 4 5 6 7 8 9 10

Event Type: User Preset

User Preset: 1:Preset 1

Trigger Source: sACN

Universe: 0

DMX Address: 1

Save

WEB REMOTE MENU: INPUTS – OWNER PRESET

Device owners can lock any of the user presets so they cannot be overwritten. This is especially useful for rental equipment to ensure a company specific preset can be reloaded and is not edited by any user.

To access this function, use the specific URL IP_Address/Preset_Owner.htm, which is not part of the main interface. Select the desired preset, activate the lock, and Update to confirm. Owner presets are indicated with a lock symbol in the display.

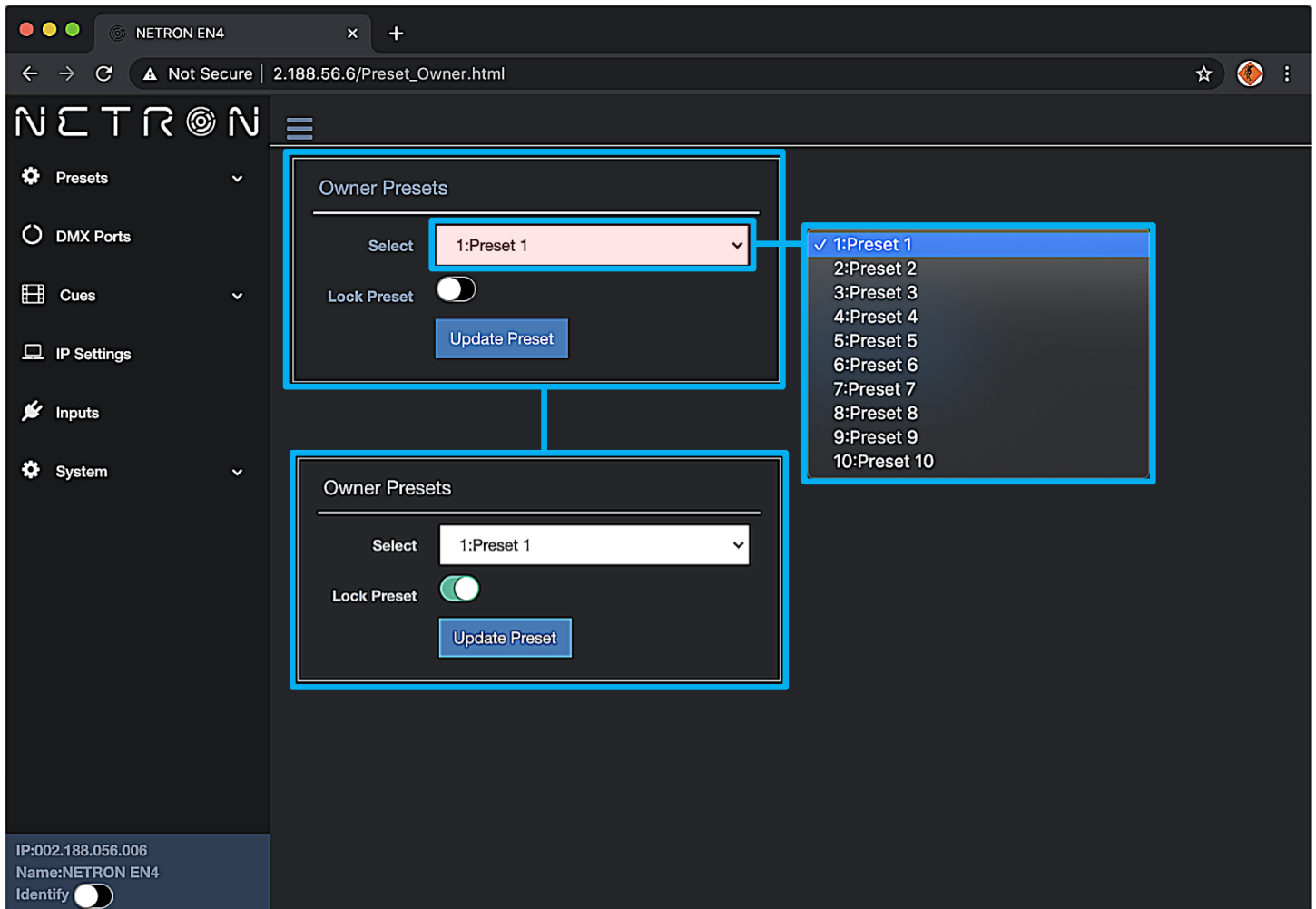

WEB REMOTE MENU: INPUTS – SEND VALUE

The screenshot shows the NETRON EN4 web interface. The left sidebar contains navigation options: Presets, DMX Ports, Cues, IP Settings, Inputs, and System. The main content area is titled "Inputs Configuration" and features a row of buttons numbered 1 to 10. Below this, there are three input fields: "Event Type" set to "Send Value", "Send Value" set to "0", and "Trigger Source" set to "Disable". A dropdown menu is open for the "Trigger Source" field, showing options: "Disable" (checked), "DMX Port", "ArtNet", and "sACN". A "Save" button is located below the "Trigger Source" field.

This close-up shows the "Inputs Configuration" interface with the "DMX Port" dropdown menu open. The "Event Type" is "Send Value" and "Send Value" is "0". The "DMX Port" dropdown shows "Port A" (checked), "Port B", "undefined", and "undefined". The "DMX Address" field is empty. A "Save" button is at the bottom.

This close-up shows the "Inputs Configuration" interface with the "ArtNet" dropdown selected. The "Event Type" is "Send Value" and "Send Value" is "0". The "Trigger Source" is "ArtNet". The "Universe" field is set to "1" and the "DMX Address" field is also set to "1". A "Save" button is at the bottom.

This close-up shows the "Inputs Configuration" interface with the "sACN" dropdown selected. The "Event Type" is "Send Value" and "Send Value" is "0". The "Trigger Source" is "sACN". The "Universe" field is set to "0" and the "DMX Address" field is set to "1". A "Save" button is at the bottom.

WEB REMOTE MENU: SYSTEM – DEVICE SETTINGS

The screenshot displays the 'NETRON EN4' web interface for system settings. The main panel is titled 'General' and includes fields for 'Device Name' (NETRON EN4), 'Device ID' (0), and 'Display Timeout' (5 Min). Below these are sliders for 'Display Brightness' (10) and 'LED Brightness' (10). The 'Art-Net Offset' is set to 'Netron Universe 1: 0-0'. The 'Home Screen' is set to 'Device Info'. There are also checkboxes for 'RDM Processing' and 'Use PIN', and a 'PIN Number' field (0).

Overlaid on the interface are several blue callout boxes showing dropdown menus:

- A menu for 'Display Timeout' with options: Disable, 10 Sec, 30 Sec, 1 Min, 5 Min (selected), 10 Min.
- A menu for 'Startup Mode' with options: Cue, Wait For Data (selected), Send 0.
- A menu for 'Signal Loss Hold Timeout' with options: Forever (selected), 0 Sec, 10 Sec, 30 Sec, 1 Min, 5 Min, 10 Min, 60 Min.
- A menu for 'Signal Loss Loss Mode' with options: Disable DMX, Fade to 0, Cue, Disable DMX (selected).
- A menu for 'Signal Loss Loss Cue' with options: 0:No Cue (selected), 1:Cue 1, 2:Cue 2, 3:Cue 3, 4:Cue 4, 96:Cue 96, 97:Cue 97, 98:Cue 98, 99:Cue 99.
- A menu for 'Art-Net Offset' with options: Netron Universe 1: 0-0 (selected), Netron Universe 1: 0-1.
- A menu for 'Home Screen' with options: Device Info (selected), Cue Browser.

At the bottom left, a smaller inset shows 'Display Brightness' (4) and 'LED Brightness' (6) sliders. At the bottom right, another inset shows 'Signal Loss' settings: 'Hold Timeout' (Forever), 'Loss Mode' (Fade to 0), and 'Fade Out (s)' (45).

Use cursor to click and drag around to desired time.

WEB REMOTE MENU: SYSTEM – STATUS

The screenshot shows a web browser window with the address bar displaying "Not Secure | 2.188.56.6/Status.html". The page title is "NETRON EN4". The main content area is titled "Status" and is divided into three sections: "Device", "IP Address", and "Firmware".

Device

Device Type	NETRON EN4
Device Name	NETRON EN4
Mac Address	42:4C:93:72:38:06
RDM UID	0x22A6-DDA87E09
On Time	34h

IP Address

Address Mode	2.X.X.X
IP Address	002.188.056.006
Net Mask	255.000.000.000

Firmware

Bootware Version	V1.4
Firmware Version	V2.4
Web Version	V2.4

At the bottom left of the page, there is a status bar showing "IP:002.188.056.006", "Name:NETRON EN4", and an "Identify" button with a circular indicator.

WEB REMOTE MENU: SYSTEM – MAINTENANCE

The screenshot displays the NETRON EN4 web interface. The browser address bar shows 'Not Secure | 2.188.56.6/About.html'. The left sidebar contains a menu with 'System' selected, which is expanded to show 'Device Settings', 'Status', and 'Maintenance'. The main content area is titled 'Maintenance' and contains three sections: 'Special Functions' with 'Reset to Default' and 'Reboot Device' buttons; 'Load Save Settings' with a file selection field (currently 'No file chosen'), 'Load Settings', and 'Save Current Settings' buttons; and 'Firmware Upgrade' with a file selection field (currently 'No file chosen') and a 'Start Upgrade' button. At the bottom left, the IP address 'IP:002.188.056.006', name 'Name:NETRON EN4', and an 'Identify' button with a light icon are visible.

FIRMWARE UPDATES

Updates for improved performance or to add additional features may be available on www.obsidiancontrol.com.

To install a firmware upgrade, connect to the device through a web browser and open the System – Maintenance menu.

Always back up the configuration first. Export to a file using the web interface.

- Upload the firmware file, then update the device. Do not power cycle during the update process. **The update is provided in two files, Display NFW and Web IMG. Both need to be installed for a full upgrade.**
- Reset to factory defaults.
- Reload the configuration file from the web interface.

Confirm the upgrade is installed from the Information/Software Version Display.

If the system menu is corrupt and or cannot be opened, then the Netron device can be updated from an IP address e.g. 2.26.206.242/update.html.

Each device has a unique Device IP Address; the one shown is only an example.

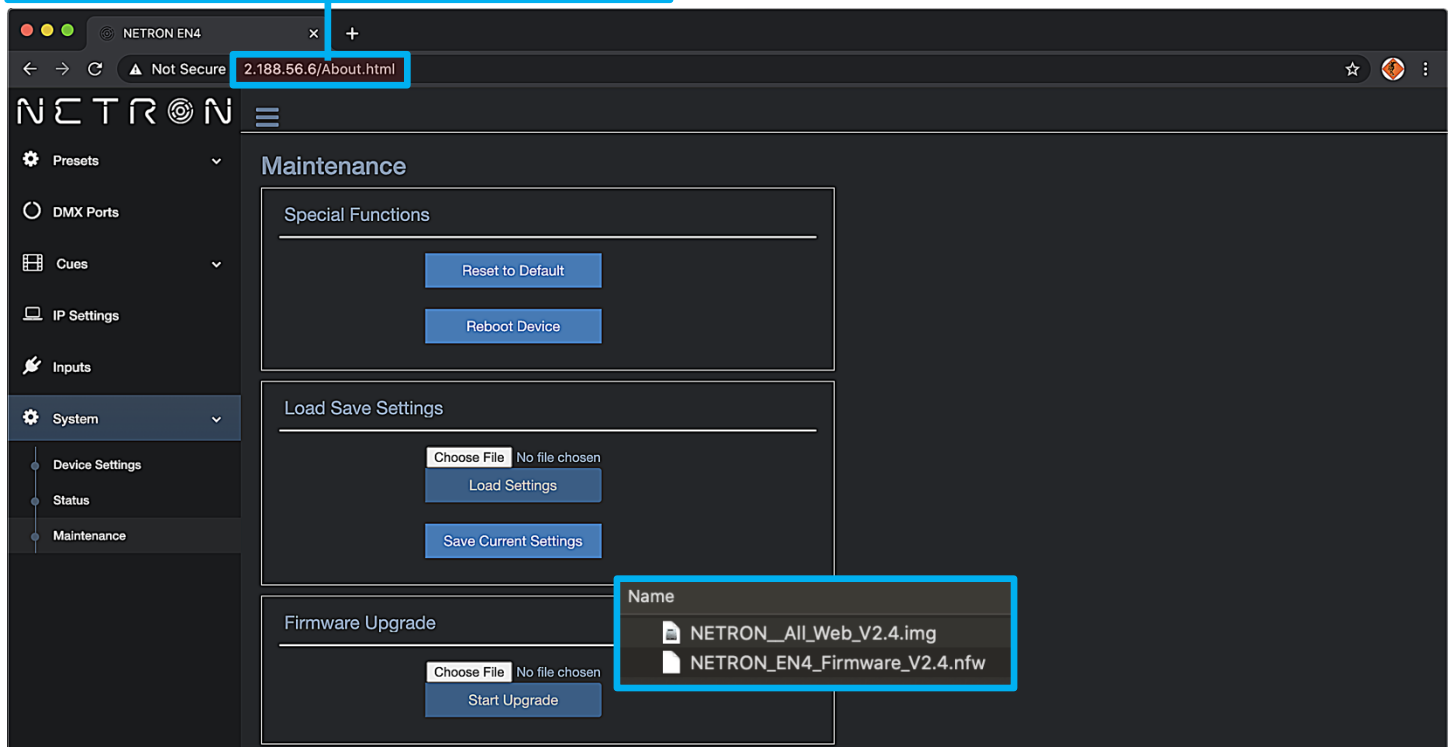

Each device has a unique Device IP Address; the one shown is only an example.

