

# CIN'K - 326LFV

CIN'K - 2500 W HID



- **Type:** Single lens luminaire
- **Source:** 2500 W HID
- **PSU:** Magnetic - hot restrike - DMX
- **Optics:** 250 mm Fresnel lens
- **Silent cooling fan for colour cassette**

Single lens

## Powerful discharge unit for theatres and more

Cin'k's cool colour temperature is perfect for ballet and daylight effects. Its 250 mm lens ensures powerful output while the theatre-inspired front cassette provides an efficient colour filter holder with no light spill. Smooth dimming is possible with a Jalousie 2 digital dimmer.

### Features

- **Silent cooling fan for colour cassette:** to extend the life of dark colour gels
- **Jalousie 2:** optional DMX-controlled digital shutter for the dimming of discharge units
- **Theatre front cassette:** no light spill to distract audiences or performers
- **Accessories holder:** double runners to hold accessories and colour filters
- **DMX remote controlled ignition**
- **Focus reference:** index for easy focus reference
- **Tilt reference on hanging yoke:** index for rapid re-positioning

### Optical

- **250 mm lens:** light output equivalent to 'studio' 300 mm fixtures

### Construction

- **Made in France :** fully manufactured in Robert Juliat premises retaining complete control over all aspects of quality
- **Separate PSU:** compact for easy handling and rapid maintenance
- **Bodywork:** strong sheet metal construction for durability
- **Moving parts:** smooth at all times, even when hot
- **Captive knobs and handles:** additional security when working at height or in transit
- **Access:** easy access to lamp house and lenses through front opening for fast and efficient maintenance
- **Easy access to all parts:** easy cleaning, re-lamping and maintenance
- **Removable assemblies:** fast-plug cable connectors and complete component assemblies (mirror, condenser set and lamp house assembly) save maintenance and cleaning time
- **Safety grid:** earthed safety grid fitted as standard
- **Safety first:** front accessories safety cable attachment point

Picture:326LF

DSEN019\_326LFV\_DMx - 05/06/2023

Robert Juliat reserves the right to change or alter any of the items detailed on this page, to increase or improve manufacturing techniques without prior notice.

Robert Juliat S.A.S., 32 rue de Beaumont, 60530 Fresnoy-en-Thelle - France  
Telephone : +33 (0)3 44 26 51 89 - info@robertjuliat.fr - www.robertjuliat.com



ROBERT JULIAT

## Source



- **Lamp type:** Discharge
- **Power:** 2500 W
- **Socket:** G38
- **Hot re-strike:** yes

Admissible lamps	Power *	Lumen output*	Colour temperature*	Life*	CRI* (min)
CSR 2500W SEHR (GE)	2 500 W	220 000 lm	6000K	500 h	90
HMI 2500W/SE XS (Osram)	2 500 W	240 000 lm	6000K	500 h	90
MSR 2500W HR (Philips)	2 500 W	240 000 lm	6000K	500 h	95
USR 2500W HR (Ushio)	2 500 W	240 000 lm	5600K	500 h	80

(\*) manufacturer's data

## Optics

### Characteristics

- **Type:** Single lens
- **Beam range:** 7° to 56°
- **Lens:** 250 mm Fresnel lens

### Gel filter

- **Shape:** Square
- **Standard size:** 333x333 mm (13.1x13.1 in)

## Photometrics

optics: 6°-53° / Standard / MSR 2500W HR (Philips)

### • Optics @ 6°

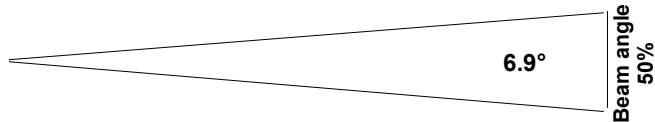
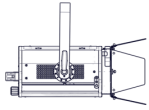

**Beam intensity**  
1 235 300 cd

<b>Distance</b>	5 m	10 m	15 m	20 m	25 m	30 m
<b>Diameter</b>	0.6 m	1.2 m	1.8 m	2.4 m	3 m	3.6 m
<b>Illumination</b>	49 500 lux	12 500 lux	5 500 lux	3 100 lux	2 000 lux	1 400 lux
<b>Distance</b>	15 ft	35 ft	50 ft	65 ft	80 ft	100 ft
<b>Diameter</b>	1.8 ft	4.2 ft	6 ft	7.8 ft	9.6 ft	12.1 ft
<b>Illumination</b>	5 500 fc	1 050 fc	500 fc	300 fc	200 fc	130 fc

### • Optics @ 53°

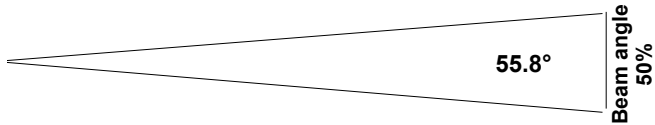
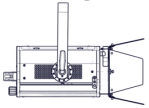

**Beam intensity**  
96 000 cd

<b>Distance</b>	5 m	10 m	15 m	20 m	25 m	30 m
<b>Diameter</b>	5.3 m	10.6 m	15.9 m	21.2 m	26.5 m	31.8 m
<b>Illumination</b>	3 850 lux	970 lux	430 lux	250 lux	160 lux	110 lux
<b>Distance</b>	15 ft	35 ft	50 ft	65 ft	80 ft	100 ft
<b>Diameter</b>	15.9 ft	37.1 ft	52.9 ft	68.8 ft	84.7 ft	105.9 ft
<b>Illumination</b>	430 fc	80 fc	39 fc	23 fc	16 fc	10 fc

## Dimensions and weight

### Unit

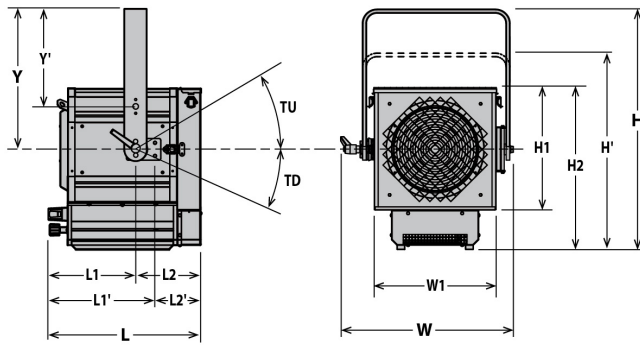

**Weight:** 24 kg (52.8 lbs)

Height	Length	Width	Yoke	Tilt
H= 560 mm (22 in)	L= 425 mm (16.7 in)	W= 465 mm (18.3 in)	Y= 270 mm (10.6 in)	TU= TBD°
H'= 670 mm (26.4 in)	L1= 250 mm (9.8 in)	W1= TBD mm (0 in)	Y'= 390 mm (15.4 in)	TD= TBD°
H1= TBD mm (0 in)	L1'= 290 mm (11.4 in)			
H2= 480 mm (18.9 in)	L2= 175 mm (6.9 in)			

### Shipping

- **Weight :** Unit: 24.6 kg (82.7 lbs)  
PSU: 37.6 kg (82.7 lbs)
- **Volume :** Unit: .14 m<sup>3</sup> (4.94 ft<sup>3</sup>)  
PSU: .13 m<sup>3</sup> (4.59 ft<sup>3</sup>)

### PSU

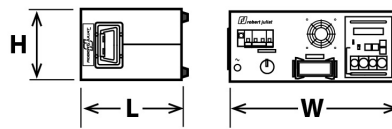

- Width:** W= 450 mm (17.7 in)
- Height:** H= 185 mm (7.3 in)
- Length:** L= 345 mm (13.6 in)
- Weight:** 32 Kg (70.4 lbs)

### Installation

- **Minimum distance to illuminated surface:** 2.7 m ( 8.9 ft )
- **Operating position:**

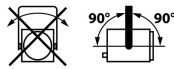

### Warranty

- **Fixture: 2 years**  
See General Sales Condition on website

### Approvals



### Construction

- **Housing:** Steel sheet - Aluminium
- **Colour:** Black
- **Cooling:** Low noise fan
- **Maximum ambient temperature (Ta):** 40°C (104°F)
- **Maximum case temperature (Tc):** 250°C (482°F)
- **Total heat dissipation:** 10 581 BTU/h
- **Ingress Protection (IP) rating:** IP20

- **PSU housing:** Steel sheet - Aluminium
- **PSU colour:** Black
- **PSU cooling:** Fans
- **PSU maximum ambient temperature (Ta):** 40°C (104°F)
- **PSU maximum case temperature (Tc):** 70°C (158°F)

### Electrical compatibility

- 220/230 V - 50 Hz
- 245 V - 50 Hz
- ~~110/120 V - 60 Hz~~
- 208 V - 60 Hz
- ~~220/230 V - 60 Hz~~
- ~~100 V - 50 Hz~~
- ~~100 V - 60 Hz~~
- Selector: local switch

### Power input



- **Type:** attached power cord
- **Cable:** HO7RNF 3G4
- **Length:** 3 m (9.8 ft)
- **Power connector:** 32A blue 2P+E 6h IEC60309 (CEE 32)

### Power consumption

Voltage	Frequency	Current	Power	Power factor
230 V	50 Hz		3100 W	
208 V	60 Hz		3100 W	
245 V	50 Hz		3100 W	

### Power Supply Unit

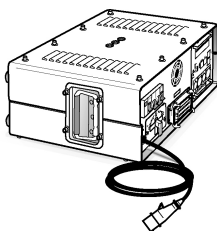

- **PSU:** Separate - Magnetic PSU
- **Lighting unit / PSU cable:** Cable attached to unit - length: 3 m (9,8 ft)  
Type: 18G1,5 JZ 602-RC (CE-UL/CSA) with 16x16A+E Harting Han® connector
- **Maximum distance between lighting unit and PSU:** 25 m (82 ft)
- **Control:** Local / DMX
- **Protection:** Mains: 25A 2P2D - C curve breaker / Electronic: 1A 1P1D - C curve breaker / Auxiliary: 6A 2P2D - C curve breaker















## Model

**326LFV DMX**

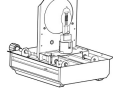
2500 W HID Single lens luminaire - 250mm Fresnel - 326LFV Cin'k - Magnetic PSU - DMX lamp control - with fan

## Options

## Accessories

<b>PF325</b>	333x333mm metal filter holder - Poids: 0.52 Kg <b>1 included</b>	
<b>G325L</b>	333x333mm safety grid - Poids: 0.44 Kg <b>1 included</b>	
<b>MSR 2500W HR</b>	MSR 2500W HR - Philips G38 2500W 500h 6000K lamp	
<b>PFR325</b>	600x600 mm extended metal filter holder with 4 clips - Poids: 1.11 Kg	
<b>CF325</b>	4 rotating leaves on a rotating barndoor - 333x333mm (without safety cable) - Poids: 2.11 Kg	
<b>PFR CF325</b>	Extended filter holder and rotating barndoor set - 333x333mm	
<b>JAL2/280 A1</b>	Ø280mm Jalousie2 dimming shutter with adaptation for Cin'k series - Poids: 4.6 Kg	
<b>JAL2/340 A1</b>	Ø340mm Jalousie2 dimming shutter with adaptation for Cin'k series - Poids: 5.7 Kg	
<b>T/325LF</b>	325LF lamp compartment - 3 meter power cable with CEE 7/7 (2P +T NF/SCHUKO) connector - Poids: 4.95 Kg	
<b>T/350LF</b>	350LF lamp compartment - 3 meter power cable with CEE 7/7 (2P +T NF/SCHUKO) connector	
<b>T/350LFV</b>	350LFV lamp compartment - fan cooled front cassette- 3 meter power cable with CEE 7/7 (2P+T NF/SCHUKO) connector	
<b>876</b>	Hook clamp 40x10mm with 28mm M10 screw for Ø35 to 50mm pipes - SWL: 50Kg - Poids: 1.25 Kg	
<b>880</b>	Hook clamp 40x10mm with 28mm M10 screw for Ø50 to 63mm pipes - SWL: 50Kg - Poids: 1.36 Kg	
<b>MLA</b>	Mini yoke (with screws) - Poids: 0.9 Kg	
<b>CS2</b>	Safety cable Ø3 mm L= 600mm - SWL: 75 Kg	