

ZEP2 - 360CLF2 CW

360 - LED 300 W



- **Type:** Single lens luminaire
- **Source:** LED 300 W
- **Optics:** 200 mm Fresnel lens
- **Colour temperature:** Cool White
- **Standard:** 110 V North american

Single lens

Low running costs, high performance

Equipped with an enhanced white LED source providing a higher output with a significant efficiency, this 200 mm Fresnel lens presents an exceptional flat and variable beam angle with very wide opening, combined with an electronic flicker-free dimmable PSU to create a powerful yet economical LED washlight. Perfect for TV studio, theatre, event and architectural applications.

Features

- **Theatre front cassette:** no light spill to distract audiences or performers
- **Accessories holder:** double runners to hold accessories and colour filters
- **Barn door:** unique rotating barn door with 4 individually rotating blades – makes even the most difficult angle possible
- **Remote setup:** all parameters can be adjusted by RDM protocol
- **Adjustable response time:** choice of fast or slow dimming for tungsten-like simulation
- **DMX:** 8 or 16 bit dimming and strobe function
- **Local setup:** dMX address and mode, dimming curve and response time through 4-button display with automatic light switch-off
- **Control:** local, DMX, wireless DMX (option)
- **Focus reference:** index for easy focus reference
- **Focus adjustment:** smooth focus adjustment from rear
- **Tilt reference on hanging yoke:** index for rapid re-positioning

Optical

- **Unique 200 mm (8 in) lens:** no equivalent on the market in terms of light output and beam quality
- **Wide angle:** up to 90° from edge to edge
- **Beam shaping :** efficient barndoors in any focus position
- **Electronic dimmer:** dimming without clipping or cut-out at low intensity levels; high quality smoothing
- **No colour shift:** colour temperature remains the same when dimming

Construction

- **Made in France :** fully manufactured in Robert Juliat premises retaining complete control over all aspects of quality
- **PSU:** built-in electronic flicker-free power supply for easy, plug-and-play installation
- **Power connectors:** neutriK® powerCON TRUE1 TOP IN and OUT connectors for daisy chaining
- **Silent-running cooling fans:** ideal for TV studios and opera houses
- **Electronic thermal management system:** ensures maximum performance of the system without any risk of overheating
- **Bodywork:** strong sheet metal construction for durability
- **Captive knobs and handles:** additional security when working at height or in transit
- **Safety first:** front accessories safety cable attachment point

Picture:360LF + CF1000

DSEN305_360CLF2_CW - 05/06/2023

Robert Juliat reserves the right to change or alter any of the items detailed on this page, to increase or improve manufacturing techniques without prior notice.

Robert Juliat S.A.S., 32 rue de Beaumont, 60530 Fresnoy-en-Thelle - France
Telephone : +33 (0)3 44 26 51 89 - info@robertjuliat.fr - www.robertjuliat.com



ROBERT JULIAT

Source

- Lamp type: LED
- Power: 247 W

LED specifications	Power *	Lumen output*	Colour temperature*	Life*	CRI* (min)
SUHD60 V3 CW (RJ / Osram)	247 W	25 725 lm	5700K	100 000 h	92

(*) manufacturer's data

Optics

Characteristics

- Type: Single lens
- Beam range: 12° to 64°
- Lens: 200 mm Fresnel lens

Gel filter

- Shape: Square
- Standard size: 215x215 mm (8.5x8.5 in)

Photometrics

optics: 12°-64° / Standard

• Optics @ 12°

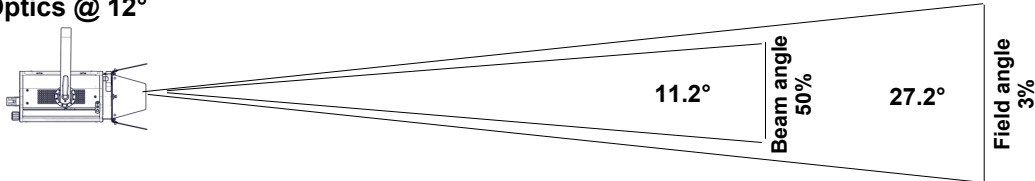

Beam intensity
155 900 cd

Distance	3 m	5 m	7 m	10 m	12 m	15 m	
Diameter	1.5 m	2.4 m	3.4 m	4.8 m	5.8 m	7.3 m	
Illumination	17 500 lux	6 300 lux	3 200 lux	1 600 lux	1 100 lux	700 lux	
Distance	10 ft	15 ft	25 ft	35 ft	40 ft	50 ft	
Diameter	4.8 ft	7.3 ft	12.1 ft	16.9 ft	19.4 ft	24.2 ft	
Illumination	1 600 fc	700 fc	250 fc	130 fc	100 fc	65 fc	

CCT
5 910 K

CRI
93

• Optics @ 64°

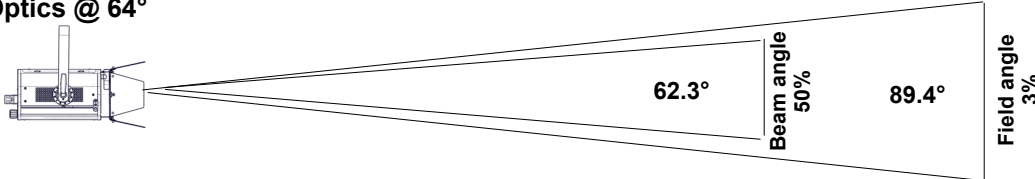

Beam intensity
13 300 cd

Distance	3 m	5 m	7 m	10 m	12 m	15 m	
Diameter	5.9 m	9.9 m	13.9 m	19.8 m	23.7 m	29.7 m	
Illumination	1 500 lux	540 lux	280 lux	140 lux	95 lux	60 lux	
Distance	10 ft	15 ft	25 ft	35 ft	40 ft	50 ft	
Diameter	19.8 ft	29.7 ft	49.5 ft	69.3 ft	79.2 ft	99 ft	
Illumination	140 fc	60 fc	22 fc	11 fc	9 fc	6 fc	

CCT
5 850 K

Remote control

- Data protocol: USITT DMX512-A
RDM

- Data IN connector: 5 pins XLR male
- Data OUT connector: 5 pins XLR female



• DMX chart:

Mode 1 (1 channels)

Dimmer

Mode 2 (4 channels)

Dimmer
Dimmer fine
-
Strobe

Mode 3 (5 channels)

Dimmer
Dimmer fine
-
Strobe
Dimmer master

Dimensions and weight

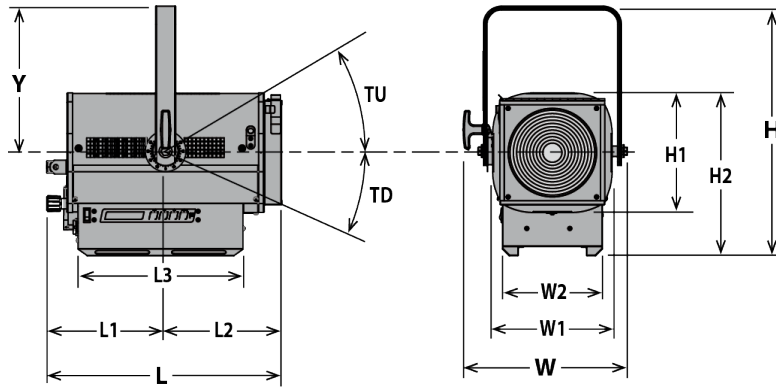

Weight: 15.2 kg (33.4 lbs)

Height	Length	Width	Yoke	Tilt
H= 520 mm (20.5 in)	L= 494 mm (19.4 in)	W= 344 mm (13.5 in)	Y= 303 mm (11.9 in)	TU= 90°
H1= 250 mm (9.8 in)	L1= 250 mm (9.8 in)	W1= 250 mm (9.8 in)		TD= 90°
H2= 342 mm (13.5 in)	L2= 244 mm (9.6 in)	W2= 210 mm (8.3 in)		
	L3= 346 mm (13.6 in)			

Shipping

- **Weight :** 18.2 kg (40 lbs)
- **Volume :** .09 m³ (3.18 ft³)

Installation

- **Minimum distance to illuminated surface:** 0.2 m (0.5 ft)
- **Operating position:**

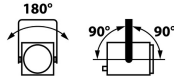

Construction

- **Housing:** Steel sheet - Aluminium
- **Colour:** Black
- **Cooling:** Low noise variable fan
- **Maximum ambient temperature (Ta):** 40°C (104°F)
- **Maximum case temperature (Tc):** 70°C (158°F)
- **Total heat dissipation:** 976 BTU/h
- **Ingress Protection (IP) rating:** IP20

Electrical compatibility

- 220/230 V - 50 Hz
- 220/230 V - 60 Hz
- 245 V - 50 Hz
- 100 V - 50 Hz
- 110/120 V - 60 Hz
- 100 V - 60 Hz
- 208 V - 60 Hz
- Selector: automatic detection

Power input



- **Type:** removable power cord with Neutrik powerCON TRUE1 TOP connector (included)
- **Cable:** 14 AWG SJ type (UL/CSA)
- **Length:** 1.5 m (4.9 ft)
- **Power connector:** without connector

Power consumption

Voltage	Frequency	Current	Power	Power factor
230 V	50 Hz	1.3 A	286 W	0.97
120 V	60 Hz	2.5 A	291 W	0.99
100 V	60 Hz	3 A	295 W	0.99

Power Supply Unit

- **PSU:** Internal - Electronic PSU - Flicker free with PFC
- **Control:** Local / DMX
- **Protection:** Mains: 4A 1P1D breaker - UL /
- **Power thru:** Neutrik powerCON TRUE1 TOP - Maximum of 10 units (230 V) / 5 units (120 V)

Warranty

- **Fixture: 3 years - Source: 5 years**
See General Sales Condition on website

Approvals



Acoustics

- **Noise level:** < 24,9 dB(A)







Model

360CLF2 CW	LED 300 W Single lens luminaire - 200mm Fresnel - 360CLF2 CW ZEP2 - Cool White - North american standard
-------------------	--

Options

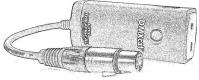
PO/Z	Pole operation yoke (PAN/TILT/Focus)	
W-DMX/ZF2	W-DMX wireless DMX	

Accessories

PF1000M2	215x215mm metal filter holder 1 included	
CF1000	4 rotating leaves on a rotating barndoor - 215x215mm (without safety cable) - Poids: 1.03 Kg	
DMXcat	Bluetooth DMX/RDM Multifunction test tool - City Theatrical DMXcat®	
876	Hook clamp 40x10mm with 28mm M10 screw for Ø35 to 50mm pipes - SWL: 50Kg - Poids: 1.25 Kg	
880	Hook clamp 40x10mm with 28mm M10 screw for Ø50 to 63mm pipes - SWL: 50Kg - Poids: 1.36 Kg	
CS2	Safety cable Ø3 mm L= 600mm - SWL: 75 Kg	
CS5	Safety cable Ø1,5 mm L=300mm for front accessory with karabiner and quick link - SWL: 25 Kg	