

ARTHUR - 1014CLT

LLT (LED LONG THROW) - LED 800 W



- **Type:** Followspot
- **Source:** LED 800 W
- **Optics:** 4° to 10° zoom
- **Colour temperature:** Cool White
- **Standard:** 110 V North american

Followspot

The Long Throw 800W LED followspot with narrow beam

Arthur LT is a new Long-Throw adaptation of the original Arthur followspot with a narrower beam. Featuring a zoom range of 4° - 10°, Arthur LT provides an output that exceeds an HMI 2500W Aramis. The LT version ensures invincible performances with an output of 2000 lux at a distance of 50m (200fc at 165 ft), while offering an enhanced light quality with a high CRI (>94) - an essential feature for a followspot whose main role is to shine a light on performers and showcase them in sublime fashion. With the choice of several ventilation modes, Arthur's sound level is much quieter than any of its discharge rivals; it can be operated as easily in opera houses as on concerts and big arenas.

Features

- **Fully closing iris:** removable for fast, easy replacement
- **Gobo holder:** glass and metal gobos
- **Ergonomic dimmer control:** one-handed dim, pan and tilt
- **Local control:** light intensity adjustment through built-in potentiometer
- **Internal glass filter holder:** long term use of durable coloured, dichroic or textured glass
- **Individually removable colour frame:** gels replaced easily while colour cassette remains in place
- **Colour changer:** 6-way, self-cancelling boomerang colour-changer
- **USB connector:** for connection of additional accessories
- **Adjustable response time:** choice of fast or slow dimming for tungsten-like simulation - adjustment by DMX protocol
- **Ethernet-DMX node:** data IN through RJ45 connector; data OUT through DMX for daisy chaining
- **Universal data control:** compatible with DMX, RDM, Art-Net, sACN protocols
- **Remote setup:** all parameters can be adjusted by RDM protocol or by web interface
- **PWM adjustment:** choice of different PWM dimming frequencies - continuous mode available
- **DMX:** 8 or 16 bit dimming and strobe function
- **Local setup:** dMX address and mode, dimming curve and response time through 4-button display with automatic light switch-off
- **Control:** local and DMX
- **Dimming parameters:** choice of square or linear dimming curves
- **Easy focus reference:** graduated scale on side of the unit; fast and easy refocusing
- **Adjustable yoke:** for optimum overhead positioning
- **Fine balance:** precision positioning and smooth operation even with the smallest movements
- **Stand:** perfectly weighted for maximum stability with smooth rotation for optimum performance. Easy set up; triple safety system for extra security

Optical

- **Long life:** outstanding operational lifetime expectation, no need to replace lamps, low maintenance
- **Native high CRI LED source:** CRI > 94 - perfect for performer illumination - no need for correction filter
- **Gobo :** excellent gobo projection
- **Optical quality:** smooth flat beam, no hot spot
- **Variable zoom optics:** sharp focus at every beam angle. Independent control of image size and focus.
- **Long Throw zoom version:** perfect for long distance applications
- **Electronic dimmer:** dimming without clipping or cut-out at low intensity levels; high quality smoothing
- **No colour shift:** colour temperature remains the same when dimming

Construction

- **Made in France :** fully manufactured in Robert Juliat premises retaining complete control over all aspects of quality
- **PSU:** built-in electronic flicker-free power supply for easy, plug-and-play installation
- **Power connectors:** neutriK® powerCON TRUE1 TOP IN and OUT connectors for daisy chaining
- **Integrated network switch :** two etherCON RJ45 connectors for Art-Net / sACN daisy chaining
- **Silent-running cooling fans:** ideal for TV studios and opera houses
- **Electronic thermal management system:** ensures maximum performance of the system without any risk of overheating
- **3 cooling modes available:** includes silent mode for perfect integration in concert halls
- **Bodywork:** strong sheet metal construction for durability
- **Ergonomic wrap-around handle:** comfort, safety and practicality from all operating positions
- **Moving parts:** smooth at all times, even when hot
- **Captive knobs and handles:** additional security when working at height or in transit
- **Easy access to all parts:** easy cleaning and maintenance
- **Independent modules for the PSU, drivers and CPU:** easy maintenance with plug & play system

Picture:1014LT

DSEN399_1014CLT - 05/06/2023

Robert Juliat reserves the right to change or alter any of the items detailed on this page, to increase or improve manufacturing techniques without prior notice.

Robert Juliat S.A.S., 32 rue de Beaumont, 60530 Fresnoy-en-Thelle - France
Telephone : +33 (0)3 44 26 51 89 - info@robertjuliat.fr - www.robertjuliat.com



ROBERT JULIAT

- Lamp type: LED
- Power: 840 W

LED specifications	Power *	Lumen output*	Colour temperature*	Life*	CRI* (min)
LED 800W LT	840 W	40 000 lm	7100K	20 000 h	95

(*) manufacturer's data

Optics

Characteristics

- Type: Zoom
- Beam range: 4° to 10°
- Focal length: - mm

Gel filter

- Shape: Circle
- Standard size: 270 mm (10.6 in)

Gobo

- Size: B
- Material: Metal
Glass

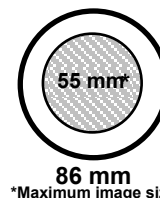

Photometrics (Photometrics report(s) available at the end of the document)

optics: 4°-10° / Standard

• Optics @ 4°

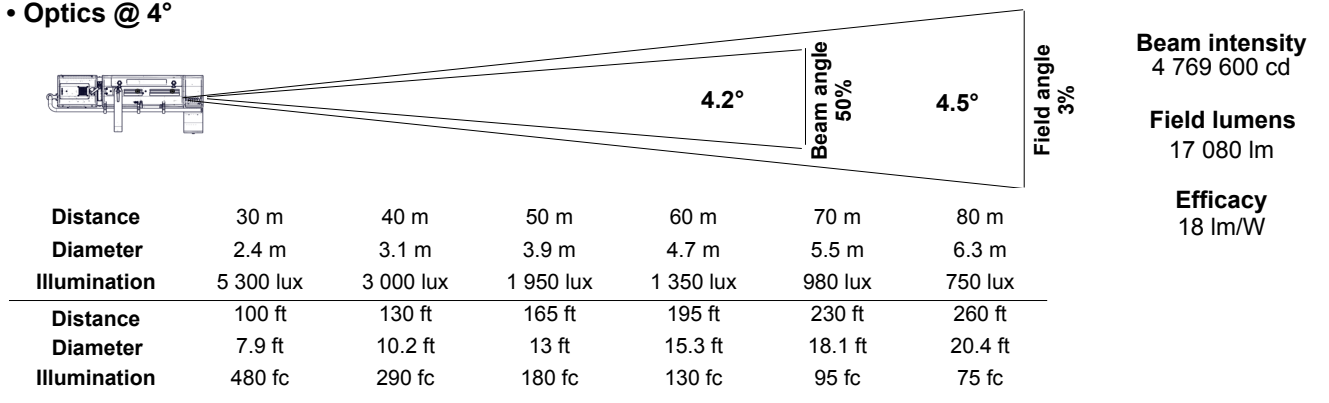

• Optics @ 10°

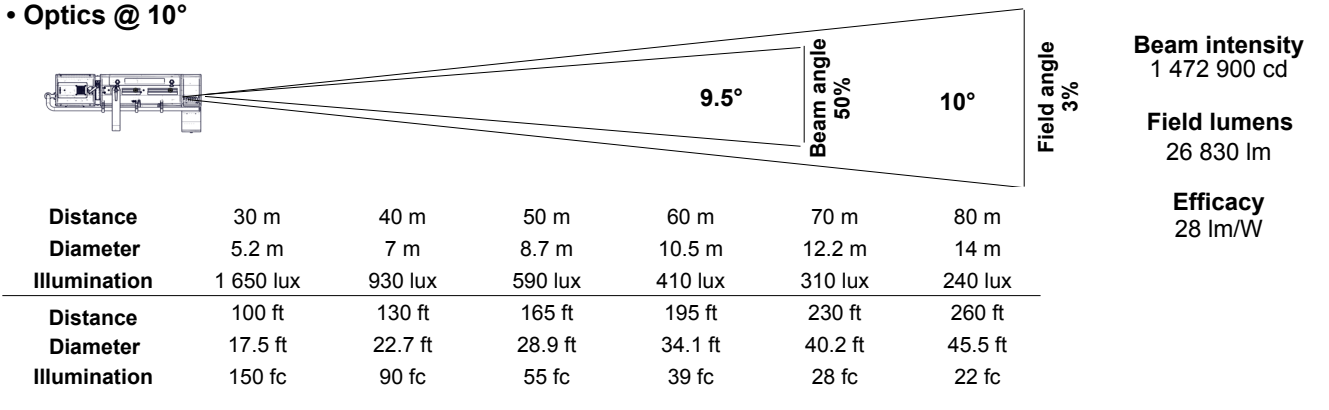

Remote control

- Data protocol: USITT DMX512-A
RDM / Art-Net / sACN

- Data IN connector: 5 pins XLR male +
2x etherCON RJ45
- Data OUT connector: 5 pins XLR female



• DMX chart:

Mode 1 (1 channels)	Mode 2 (2 channels)	Mode 3 (5 channels)	Mode 4 (6 channels)	Mode 5 (6 channels)	Mode 6 (8 channels)
Dimmer	Dimmer Dimmer fine	Dimmer Strobe duration Strobe speed Response time Control mode	Dimmer Dimmer fine Strobe duration Strobe speed Response time Control mode	Dimmer Master dimmer Strobe duration Strobe speed Response time Control mode	Dimmer Dimmer fine Master dimmer Master dimmer fine Strobe duration Strobe speed Response time Control mode

Dimensions and weight

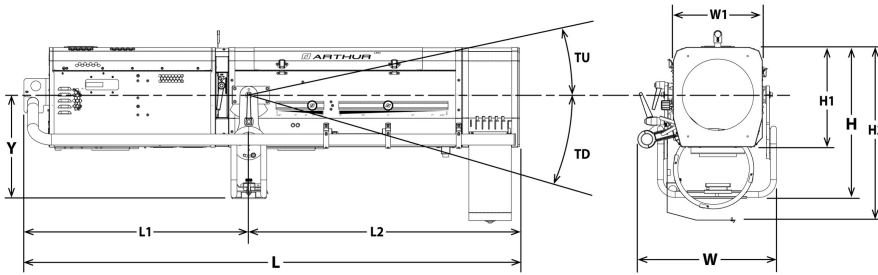

Weight: 68.8 kg (151.4 lbs)

Height	Length	Width	Yoke	Tilt
H= 508 mm (20 in)	L= 1665 mm (65.6 in)	W= 461 mm (18.1 in)	Y= 340 mm (13.4 in)	TU= 30°
H1= 345 mm (13.6 in)	L1= 755 mm (29.7 in)	W1= 300 mm (11.8 in)		TD= 61°
H2= 590 mm (23.2 in)	L2= 910 mm (35.8 in)			

Shipping

- **Weight :** 113 kg (248.6 lbs)
- **Volume :** 1.1 m³ (38.84 ft³)

Installation

- **Minimum distance to illuminated surface:** 1.3 m (4.3 ft)
- **Operating position:**

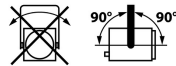

Construction

- **Housing:** Steel sheet - Aluminium
- **Colour:** Black
- **Cooling:** Variable fans
- **Maximum ambient temperature (Ta):** 40°C (104°F)
- **Maximum case temperature (Tc):** 51°C (123.8°F)
- **Total heat dissipation:** 3 516 BTU/h
- **Ingress Protection (IP) rating:** IP20

Electrical compatibility

- 220/230 V - 50 Hz
- 245 V - 50 Hz
- 110/120 V - 60 Hz
- 208 V - 60 Hz
- 220/230 V - 60 Hz
- 100 V - 50 Hz
- 100 V - 60 Hz
- Selector: automatic detection

Power input



- **Type:** removable power cord with Neutrik powerCON TRUE1 TOP connector (included)
- **Cable:** 14 AWG SJ type (UL/CSA)
- **Length:** 1.5 m (4.9 ft)
- **Power connector:** without connector

Power consumption

Voltage	Frequency	Current	Power	Power factor
120 V	60 Hz	8.7 A	1030 W	0.98
230 V	50 Hz	4.3 A	960 W	0.97
100 V	60 Hz	10.7 A	1080 W	0.98

Power Supply Unit

- **PSU:** Internal - Electronic PSU - Flicker free with PFC
- **Control:** Local / DMX
- **Protection:** Mains: 20A 2P 2D fast switch breaker - UL /
- **Power thru:** Neutrik powerCON TRUE1 TOP - Maximum of 3 units (230 V) / 1 units (120 V)

Warranty

- **Fixture: 3 years**
See General Sales Condition on website

Approvals



Acoustics

- **Noise level:** < 34,9 dB(A)







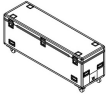



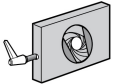



Model











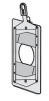

1014CLT	LED 800 W Followspot - 1014CLT Arthur - Cool White - 4/10° - North american standard
----------------	--

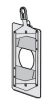
Options

M270/2TM	6 ways "push/pull" colour changer	
FC1014	Flight-case for LLT range / GT stand / accessories - Dim: 1838x599x873mm - Weight: 68 Kg	

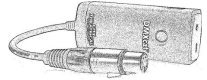
Accessories

CCU2	Full closing iris cassette - Ø55mm - Poids: 1.35 Kg 1 included	
PF1013	Ø270 mm metal filter holder - Poids: 0.2 Kg 6 included	
SGUB2	Universal "B" size gobo-holder (metal, glass, frosted glass) 1 included	
VDM120	Ø120mm frosted glass with holder 1 included	
M270/2B	6 ways "boomerang" colour changer - Poids: 5.9 Kg 1 included	
SAC1	RJ Cable strap (25x500mm) 1 included	
CCU2SM	Full closing iris cassette with position sensor for SpotMe system - Ø55mm	
GT4000	Tripod stand with safety chain - SWL: 130 Kg - max. height: 1030 mm - Poids: 7.91 Kg	
GT4000R	Tripod stand with ball head rotation with security chain - SWL: 130 Kg - max. height: 1030 mm - Poids: 10 Kg	
GT4000RSM	Tripod stand with ball head rotation with security chain and SpotMe PAN sensor - SWL: 130 Kg - max. height: 1030 mm	
GT4000S	Tripod stand without safety chain - SWL: 130 Kg - max. height: 1030 mm - Poids: 8.65 Kg	
JPP	Monopod stand for overhead followspot - Poids: 3.6 Kg	
T4000	Followspot mount for Ø50mm pipe (suspension or overhead) - SWL= 100 Kg - Poids: 4.88 Kg	
T4000RSM	Followspot mount with ball head rotation and SpotMe PAN sensor - SWL = 100 Kg - Poids: 8.53 Kg	

FCM120R/2	Ø120mm 1/2 CTO correction filter (Rosco #3408) with holder	
VD120	120x120mm frosted glass	
FRO/SMCPD	Heavy duty adjustable yoke equipped with TILT SpotMe sensor (C type)	
G80/2	Ø80mm horizontal chopper	
GR120/2	Slot reducer for SGUP gobo holder (if PG80/2 option)	
Kit G80/2	Ø80mm chopper kit (G80/2+ GR120/2+ adaptation kit)	
M270/2T	6 ways "push/pull" colour changer - Poids: 6.9 Kg	
H/1014	Dust cover	
Kit TELRAD	Telrad followspot sight with raiser and universal mounting kit - Poids: 1.23 Kg	
SDUP	Followspot cue sheet holder with universal mounting kit	
TCSM	SpotMe calibration tool kit	
DMXcat	Bluetooth DMX/RDM Multifunction test tool - City Theatrical DMXcat®	
Maestro	Maestro server for SpotMe - rackable unit: 1U - half 19" - Poids: 1.2 Kg	
SMS	SpotMe server + 2 sensor cables + flight case	
FC1014/S	Flight-case for LLT range / GT stand / accessories - Poids: 68 Kg	

• Optics @ 4°

Field lumens	Beam lumens	Efficacy	Beam intensity	CCT	Delta uv
17 080 Lm		18 Lm/W	4 769 600 Cd	5 840 K	

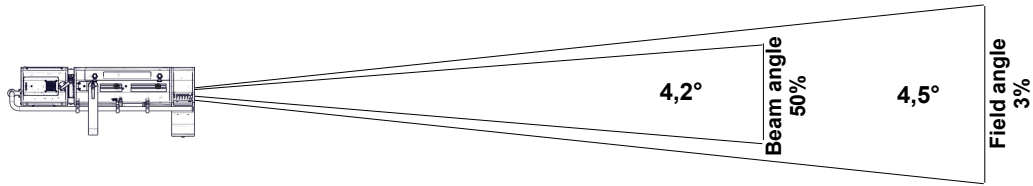

Distance	30 m	40 m	50 m	60 m	70 m	80 m
Field diameter	2,4 m	3,1 m	3,9 m	4,7 m	5,5 m	6,3 m
Illumination	5 300 lux	3 000 lux	1 950 lux	1 350 lux	980 lux	750 lux
Distance	100 ft	130 ft	165 ft	195 ft	230 ft	260 ft
Field diameter	7,9 ft	10,2 ft	13 ft	15,3 ft	18,1 ft	20,4 ft
Illumination	480 fc	290 fc	180 fc	130 fc	95 fc	75 fc

• Optics @ 7,5°

Field lumens	Beam lumens	Efficacy	Beam intensity	CCT	Delta uv
24 750 Lm		26 Lm/W	2 523 800 Cd	5 940 K	

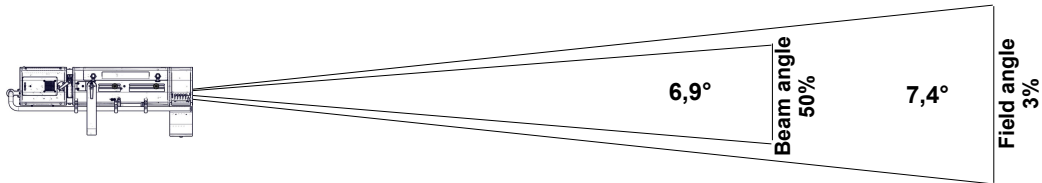

Distance	30 m	40 m	50 m	60 m	70 m	80 m
Field diameter	3,9 m	5,2 m	6,5 m	7,8 m	9,1 m	10,3 m
Illumination	2 850 lux	1 600 lux	1 050 lux	710 lux	520 lux	400 lux
Distance	100 ft	130 ft	165 ft	195 ft	230 ft	260 ft
Field diameter	12,9 ft	16,8 ft	21,3 ft	25,2 ft	29,7 ft	33,6 ft
Illumination	260 fc	150 fc	95 fc	70 fc	48 fc	38 fc

• Optics @ 10°

Field lumens	Beam lumens	Efficacy	Beam intensity	CCT	Delta uv
26 830 Lm		28 Lm/W	1 472 900 Cd	5 960 K	

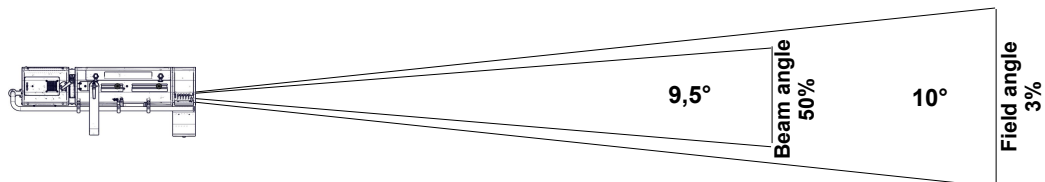

Distance	30 m	40 m	50 m	60 m	70 m	80 m
Field diameter	5,2 m	7 m	8,7 m	10,5 m	12,2 m	14 m
Illumination	1 650 lux	930 lux	590 lux	410 lux	310 lux	240 lux
Distance	100 ft	130 ft	165 ft	195 ft	230 ft	260 ft
Field diameter	17,5 ft	22,7 ft	28,9 ft	34,1 ft	40,2 ft	45,5 ft
Illumination	150 fc	90 fc	55 fc	39 fc	28 fc	22 fc

Light quality report

CCT	DeltaUV	CRI Ra	CRI R9	CQS Qa	TM30-18 Rf	TM30-18 Rg	TLCI	SSI [D5775]
5 580K	0.0016	94	81	92	92	101	96	74

CRI - CIE Colour Rendering Index

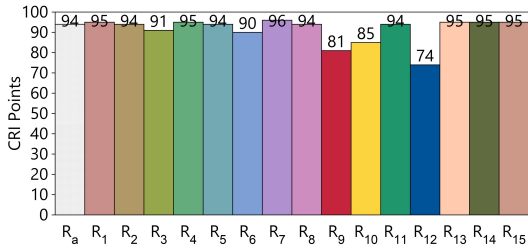

TLCI - Television Lighting Consistency Index

Spectre : CCT = D5775 (-0.3)
 TLCI-2012 : 96 (D5775)

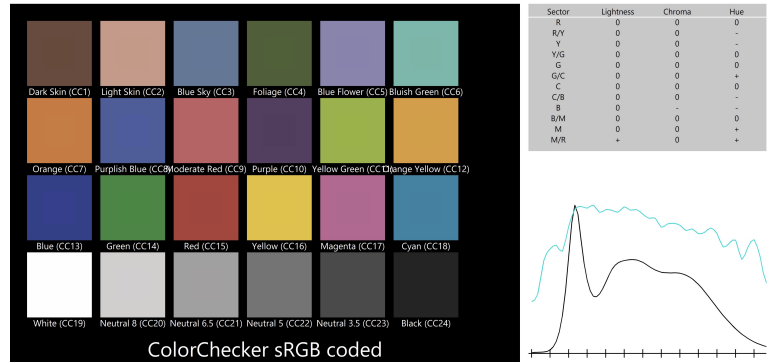

CQS - NIST Colour Quality Scale

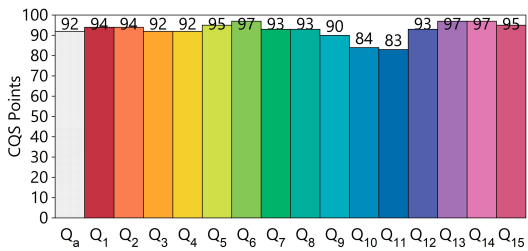

ANSI/IES TM-30-18 Colour Rendition Report

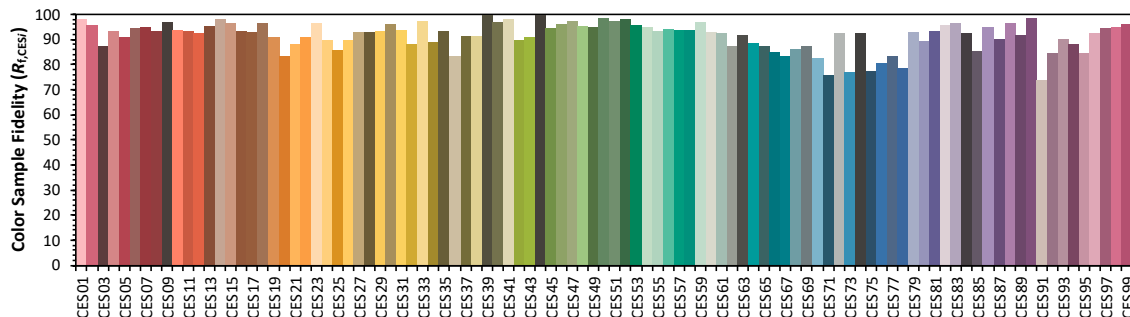
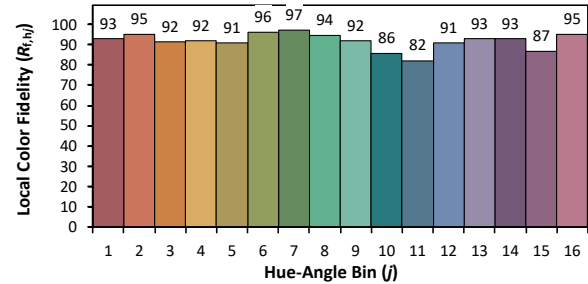
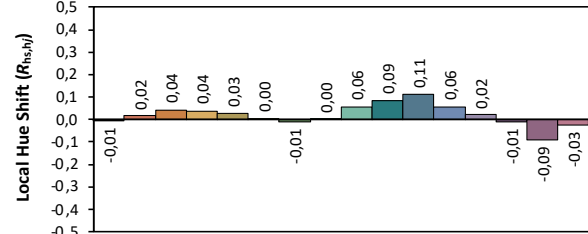
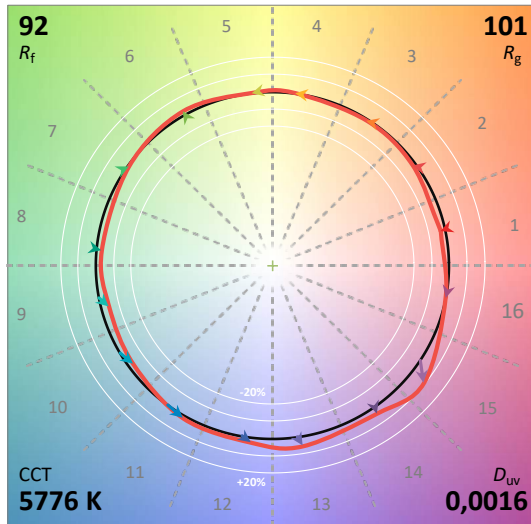
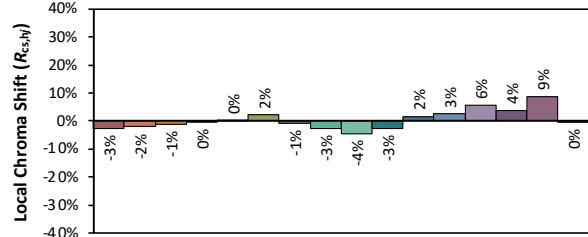
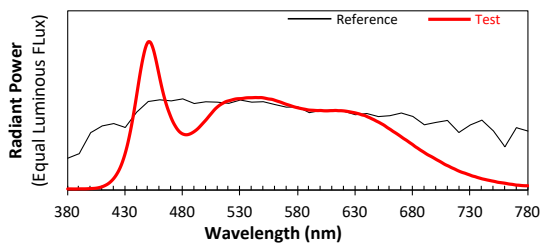

Colours are for visual orientation purposes only. Created with the IES TM-30-18 Calculator Version 2.00