

# ALEX - III7C

COMPACT - 2000 W TUNGSTEN



- **Type:** Followspot
- **Source:** 2000 W Tungsten
- **Optics:** 7° to 14.5° zoom
- **Standard:** North american

Followspot

## Television's tungsten favourite

The Alex long throw tungsten followspot blends well with conventional theatre lighting and maintains the flat beam and constant colour temperature during dimming which is so important to sensitive camera equipment. Ideal for television studios, opera houses and ballets.

### Features

- **Fully closing iris cassette:** removable for fast, easy replacement; protective backplate for extended lifespan
- **Universal adjustable gobo holder:** "A" size glass and metal gobos
- **Ergonomic dimmer control:** one-handed dim, pan and tilt. Dimmer control can be adjusted to suit the operator's preference
- **Smooth dimmer shutter:** retains flat beam and colour temperature when dimming
- **Frost filter:** on flip lever for quick soft-edge beam effect
- **Horizontal chopper (optional):** for masking control in TV studios and wide stages
- **Internal glass filter holder:** long term use of durable coloured, dichroic or textured glass
- **Individually removable colour frame:** gels replaced easily while colour cassette remains in place
- **Colour changer:** 6-way, self-cancelling boomerang colour-changer
- **Easy focus reference:** graduated scale on side of the unit; fast and easy refocusing
- **Adjustable yoke (optional):** for optimum overhead positioning
- **Fine balance:** precision positioning and smooth operation even with the smallest movements
- **Stand:** perfectly weighted for maximum stability with smooth rotation for optimum performance. Easy set up; triple safety system for extra security

### Optical

- **Factory set optical train:** travels safely within followspot and requires no time-consuming realignment on arrival. Uniform beam on all followspots of same type
- **SX optical system:** double condenser optics for exceptional optical quality
- **Gobo :** excellent gobo projection
- **Variable zoom optics:** sharp focus at every beam angle. Independent control of image size and focus.

### Construction

- **Made in France :** fully manufactured in Robert Juliat premises retaining complete control over all aspects of quality
- **Local ON/OFF switch**
- **G22 socket locking system exclusive to Robert Juliat:** holds the lamp securely in place to ensure there is no arcing, even when the fixture is pointing vertically downward
- **Bodywork:** strong sheet metal construction for durability
- **Ergonomic wrap-around handle:** comfort, safety and practicality from all operating positions
- **Moving parts:** smooth at all times, even when hot
- **Captive knobs and handles:** additional security when working at height or in transit
- **Easy access to all parts:** easy cleaning, re-lamping and maintenance
- **Removable assemblies:** fast-plug cable connectors and complete component assemblies (mirror, condenser set and lamp house assembly) save maintenance and cleaning time

Picture:1117

DSEN092\_1117C - 23/03/2022

Robert Juliat reserves the right to change or alter any of the items detailed on this page, to increase or improve manufacturing techniques without prior notice.

Robert Juliat S.A.S., 32 rue de Beaumont, 60530 Fresnoy-en-Thelle - France  
Telephone : +33 (0)3 44 26 51 89 - fax : +33 (0)3 44 26 90 79 - info@robertjuliat.fr  
www.robertjuliat.com



ROBERT JULIAT

## Source



- **Lamp type:** Tungsten
- **Socket:** G22

Admissible lamps	Power *	Lumen output*	Colour temperature*	Life*
LIF: CP92 - 120V - ANSI: CP92 -	2 000 W	55 000 lm	3200K	400 h

(\*) manufacturer's data

## Optics

### Characteristics

- **Type:** Zoom
- **Beam range:** 7° to 14.5°
- **Focal length:** 283 - 589 mm

### Gel filter

- **Shape:** Circle
- **Standard size:** 210 mm (8.3 in)

### Gobo

- **Size:** A
- **Material:** Metal  
Glass



## Photometrics

with LIF: CP92 source

### • Optics @ 7°

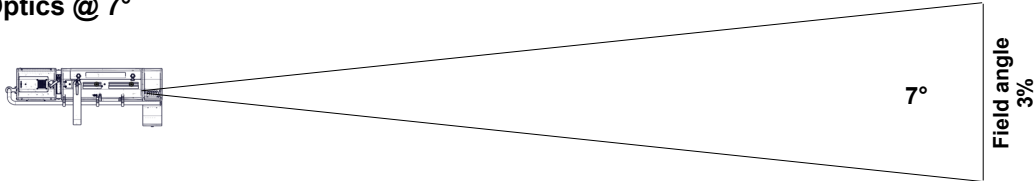

**Beam intensity**  
607 500 cd

<b>Distance</b>	15 m	20 m	25 m	30 m	35 m	40 m
<b>Diameter</b>	1.8 m	2.4 m	3.1 m	3.7 m	4.3 m	4.9 m
<b>Illumination</b>	2 750 lux	1 550 lux	980 lux	680 lux	500 lux	380 lux
<b>Distance</b>	50 ft	65 ft	80 ft	100 ft	115 ft	130 ft
<b>Diameter</b>	6.1 ft	8 ft	9.8 ft	12.2 ft	14.1 ft	15.9 ft
<b>Illumination</b>	250 fc	150 fc	95 fc	65 fc	46 fc	36 fc

### • Optics @ 14.5°

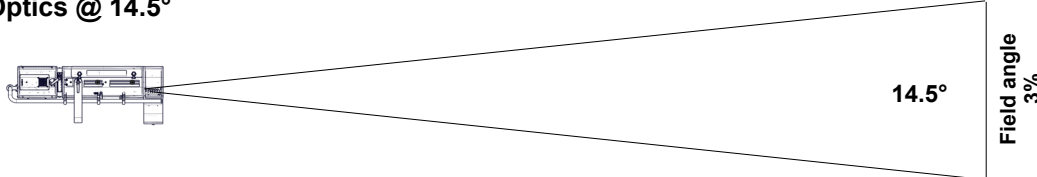

**Beam intensity**  
236 000 cd

<b>Distance</b>	15 m	20 m	25 m	30 m	35 m	40 m
<b>Diameter</b>	3.8 m	5.1 m	6.4 m	7.6 m	8.9 m	10.2 m
<b>Illumination</b>	1 050 lux	600 lux	380 lux	270 lux	200 lux	150 lux
<b>Distance</b>	50 ft	65 ft	80 ft	100 ft	115 ft	130 ft
<b>Diameter</b>	12.7 ft	16.5 ft	20.4 ft	25.4 ft	29.3 ft	33.1 ft
<b>Illumination</b>	95 fc	60 fc	37 fc	24 fc	18 fc	14 fc

## Dimensions and weight

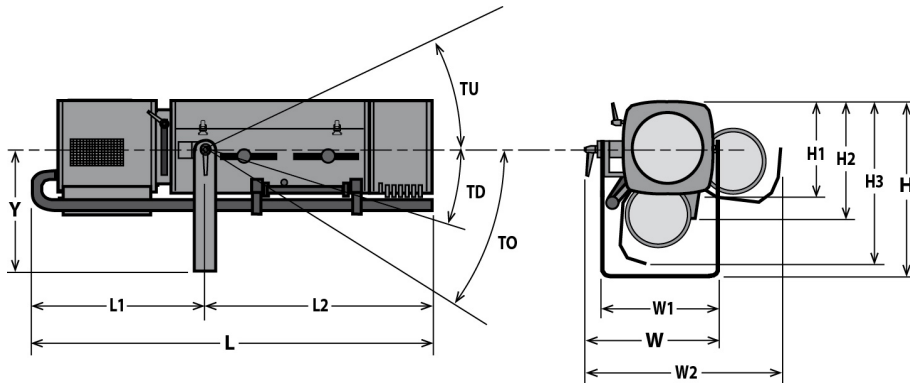

**Weight:** 30 kg (66 lbs)

Height	Length	Width	Yoke	Tilt	Option
H= 450 mm (17.7 in)	L= 1190 mm (46.9 in)	W= 410 mm (16.1 in)	Y= 325 mm (12.8 in)	TU= 35°	TO= TBD°
H1= 250 mm (9.8 in)	L1= 500 mm (19.7 in)	W1= 350 mm (13.8 in)		TD= 35°	
H2= 320 mm (12.6 in)	L2= 690 mm (27.2 in)	W2= 570 mm (22.4 in)			
H3= 460 mm (18.1 in)					

## Shipping

- **Weight :** 35 kg (77 lbs)
- **Volume :** .26 m<sup>3</sup> (9.18 ft<sup>3</sup>)

## Installation

- **Minimum distance to illuminated surface:** 2.8 m ( 9.2 ft )
- **Operating position:**

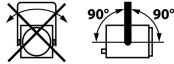

## Construction

- **Housing:** Steel sheet - Aluminium
- **Colour:** Black
- **Cooling:** Low noise fan
- **Maximum ambient temperature (Ta):** 40°C (104°F)
- **Maximum case temperature (Tc):** 270°C (518°F)
- **Total heat dissipation:** 6 826 BTU/h
- **Ingress Protection (IP) rating:** IP20

## Electrical compatibility

- 230/240 V - 50 Hz
- 115/120 V - 60 Hz

## Power input



- **Type:** attached power cord
- **Cable:** 12 AWG SJ type (UL/CSA)
- **Length:** 1.5 m (4.9 ft)
- **Power connector:** without connector

## Power consumption

Voltage	Frequency	Current	Power
120 V	60 Hz	17 A	2000 W

## Warranty

- **Fixture: 2 years**  
See General Sales Condition on website







## Approvals











## Model

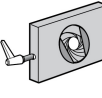

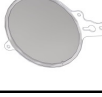

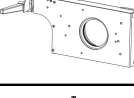













<b>1117C</b>	2000 W Tungsten Followspot - G22 socket - 1117C Alex - 7/14.5° - North american standard
--------------	--

## Options

<b>FRO/1117PV</b>	Heavy duty adjustable yoke	
<b>FRO/SMDPV</b>	Heavy duty adjustable yoke equipped with TILT SpotMe sensor (D type)	
<b>PG80</b>	Ø80mm chopper kit (G80+ GR120+ adaptation kit)	
<b>M210TM</b>	6 ways "push/pull" colour changer	
<b>CAV700P1</b>	Double slot front cassette for 215x215mm accessories (instead of "boomerang" colour changer)	
<b>FC1459</b>	Flight-case for Compact range / GT stand / P.S.U. / accessories - Dim: 1340x710x700mm - Weight: 55 Kg	

## Accessories

<b>CCU1</b>	Full closing iris cassette - Ø72mm - Poids: 1.33 Kg <b>1 included</b>	
<b>PF1011</b>	Ø210 mm metal filter holder <b>6 included</b>	
<b>SGUP2</b>	Universal "A" size gobo-holder (metal, glass, frosted glass) <b>1 included</b>	
<b>VDM100</b>	Ø97mm frosted glass with holder <b>1 included</b>	
<b>M210B</b>	6 ways "boomerang" colour changer - Poids: 3.36 Kg <b>1 included</b>	
<b>CCU1SM</b>	Full closing iris cassette with position sensor for SpotMe system - Ø72mm	
<b>GT1000</b>	Tripod stand - SWL: 40 Kg - max. height: 1550 mm - Poids: 9.27 Kg	
<b>GT4000</b>	Tripod stand with safety chain - SWL: 130 Kg - max. height: 1030 mm - Poids: 7.91 Kg	
<b>GT4000RSM</b>	Tripod stand with ball head rotation with security chain and SpotMe PAN sensor - SWL: 130 Kg - max. height: 1030 mm	
<b>GT4000S</b>	Tripod stand without safety chain - SWL: 130 Kg - max. height: 1030 mm - Poids: 8.65 Kg	

<b>JPP</b>	Monopod stand for overhead followspot - Poids: 3.6 Kg	
<b>T1000</b>	TV spigot with followspots swivel head - Poids: 1.82 Kg	
<b>T4000</b>	Followspot mount for Ø50mm pipe (suspension or overhead) - SWL= 100 Kg - Poids: 4.88 Kg	
<b>T4000RSM</b>	Followspot mount with ball head rotation and SpotMe PAN sensor - SWL = 100 Kg - Poids: 8.53 Kg	
<b>CAV700A</b>	Double slot front cassette for 215x215mm accessories - Poids: 0.52 Kg	
<b>CAV700NA</b>	Single slot front holder for 254x254mm (10x10") accessories - Poids: 0.26 Kg	
<b>VD120</b>	120x120mm frosted glass	
<b>FRO/1017PD</b>	Heavy duty adjustable yoke - Poids: 4.33 Kg	
<b>FRO/SMDPD</b>	Heavy duty adjustable yoke equipped with TILT SpotMe sensor (D type)	
<b>G80</b>	Ø80mm horizontal chopper - Poids: 0.37 Kg	
<b>GR120</b>	Slot reducer for SGUP gobo holder (if PG80 option ) - Poids: 0.2 Kg	
<b>Kit G80</b>	Ø80mm chopper kit (G80+ GR120+ adaptation kit) - Poids: 0.69 Kg	
<b>M210T</b>	6 ways "push/pull" colour changer - Poids: 3.67 Kg	
<b>M210TVCL</b>	Light shield for M210T push/pull colour changer - Poids: 1.98 Kg	
<b>Kit TELRAD</b>	Telrad followspot sight with raiser and universal mounting kit - Poids: 1.23 Kg	
<b>SDUP</b>	Followspot cue sheet holder with universal mounting kit	
<b>TCSM</b>	SpotMe calibration tool kit	
<b>Maestro</b>	Maestro server for SpotMe - rackable unit: 1U - half 19" - Poids: 1.2 Kg	
<b>SMS</b>	SpotMe server + 2 sensor cables + flight case	

**FC1459/S**

Flight-case for Compact range / GT stand / P.S.U. / accessories -  
Poids: 55 Kg

