

CRICKET - 1116

ULTRA COMPACT - 1000/1200 W TUNGSTEN



- **Type:** Followspot
- **Source:** 1000/1200 W Tungsten - Low noise fan
- **Optics:** 10.5° to 22.5° zoom

Followspot

Anything else just isn't cricket!

The smallest of the followspot range with the optical excellence of its larger counterparts. Cricket's ultra compact dimensions and low power consumption make it the perfect introduction to Robert Juliat for discerning schools, amateur dramatics and smaller venues.

Features

- **Fully closing iris:** removable for fast, easy replacement
- **Universal gobo holder:** "A" size glass and metal gobo
- **Internal glass filter holder:** long term use of durable coloured, dichroic or textured glass
- **Colour changer:** 6-way, 'push/pull' colour changer system for simultaneous use of multiple filters
- **Easy focus reference:** graduated scale on side of the unit; fast and easy refocusing

Optical

- **SX optical system:** double condenser optics for exceptional optical quality
- **Variable zoom optics:** sharp focus at every beam angle. Independent control of image size and focus.

Construction

- **Made in France :** fully manufactured in Robert Juliat premises retaining complete control over all aspects of quality
- **Bodywork:** strong sheet metal construction for durability
- **Moving parts:** smooth at all times, even when hot
- **Captive knobs and handles:** additional security when working at height or in transit
- **Easy access to all parts:** easy cleaning, re-lamping and maintenance

Picture:1116A

DSEN091_1116 - 05/06/2023

Robert Juliat reserves the right to change or alter any of the items detailed on this page, to increase or improve manufacturing techniques without prior notice.

Robert Juliat S.A.S., 32 rue de Beaumont, 60530 Fresnoy-en-Thelle - France
Telephone : +33 (0)3 44 26 51 89 - info@robertjuliat.fr - www.robertjuliat.com



ROBERT JULIAT

Source



- **Lamp type:** Tungsten
- **Socket:** G22

Admissible lamps	Power *	Lumen output*	Colour temperature*	Life*
LIF: CP71/CP40 - ANSI: FKJ	1 000 W	26 000 lm	3200K	200 h
LIF: CP93	1 200 W	30 000 lm	3200K	200 h

(*) manufacturer's data

Optics

Characteristics

- **Type:** Zoom
- **Beam range:** 10.5° to 22.5°
- **Focal length:** 189 - 408 mm

Gel filter

- **Shape:** Circle
- **Standard size:** 165 mm (6.5 in)

Gobo

- **Size:** A
- **Material:** Metal
Glass



Photometrics

optics: 10,5°-22,5° / Standard / LIF: CP93 1200W

• Optics @ 10.5°

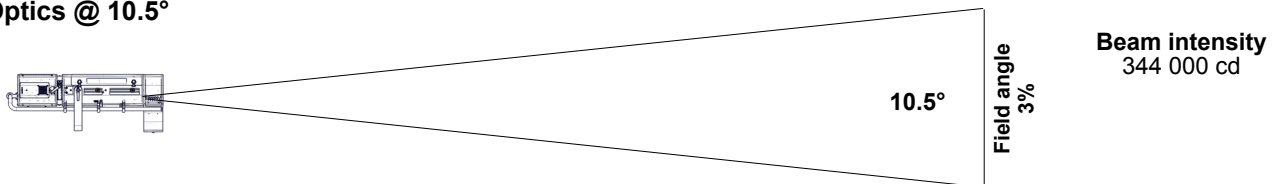

Distance	5 m	10 m	15 m	20 m	25 m	30 m
Diameter	0.9 m	1.8 m	2.8 m	3.7 m	4.6 m	5.5 m
Illumination	14 000 lux	3 450 lux	1 550 lux	870 lux	560 lux	390 lux
Distance	15 ft	35 ft	50 ft	65 ft	80 ft	100 ft
Diameter	2.8 ft	6.4 ft	9.2 ft	11.9 ft	14.7 ft	18.4 ft
Illumination	1 550 fc	290 fc	140 fc	85 fc	55 fc	35 fc

• Optics @ 22.5°

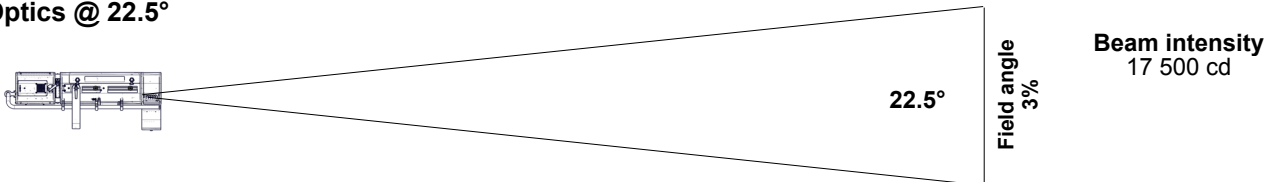

Distance	5 m	10 m	15 m	20 m	25 m	30 m
Diameter	2 m	4 m	6 m	8 m	9.9 m	11.9 m
Illumination	710 lux	180 lux	80 lux	44 lux	29 lux	20 lux
Distance	15 ft	35 ft	50 ft	65 ft	80 ft	100 ft
Diameter	6 ft	13.9 ft	19.9 ft	25.9 ft	31.8 ft	39.8 ft
Illumination	80 fc	15 fc	8 fc	5 fc	3 fc	2 fc

Dimensions and weight

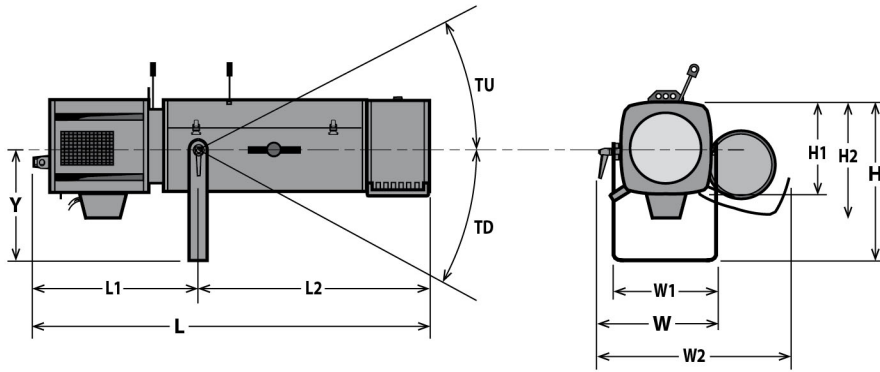

Weight: 16 kg (35.2 lbs)

Height	Length	Width	Yoke	Tilt
H= 390 mm (15.4 in)	L= 920 mm (36.2 in)	W= 330 mm (13 in)	Y= 283 mm (11.1 in)	TU= 45°
H1= 208 mm (8.2 in)	L1= 350 mm (13.8 in)	W1= 208 mm (8.2 in)		TD= 45°
H2= 265 mm (10.4 in)	L2= 570 mm (22.4 in)	W2= 490 mm (19.3 in)		

Shipping

- **Weight :** 18.8 kg (41.4 lbs)
- **Volume :** .16 m³ (5.65 ft³)

Installation

- **Minimum distance to illuminated surface:** 2.5 m (8.2 ft)
- **Operating position:**



Construction

- **Housing:** Steel sheet - Aluminium
- **Colour:** Black
- **Cooling:** Low noise fan
- **Maximum ambient temperature (Ta):** 40°C (104°F)
- **Maximum case temperature (Tc):** 260°C (500°F)
- **Total heat dissipation:** 3 413 BTU/h
- **Ingress Protection (IP) rating:** IP20

Electrical compatibility

- 230/240 V - 50 Hz
- ~~115/120 V - 60 Hz~~

Power input



- **Type:** attached power cord
- **Cable:** H07RNF 3G1.5
- **Length:** 3 m (9.8 ft)
- **Power connector:** CEE 7/7 (2P+E NF/Schuko)

Power consumption

Voltage	Frequency	Current	Power
230 V	50 Hz	5 A	1000 W
230 V	50 Hz	6 A	1200 W

Warranty

- **Fixture: 2 years**
See General Sales Condition on website



Approvals

















Model





1116	1000/1200 W Tungsten Followspot - G22 socket - 1116 Cricket - 10.5/22.5°
-------------	--------------------------------------------------------------------------

Options

PCP1716A	16A blue 2P+E 6h IEC60309 power connector	
FC1124	Flight-case for Ultra Compact range / GT stand - Dim: 1210x600x560mm - Weight: 35 Kg	

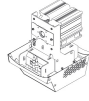
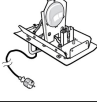
Accessories

IS750	Full closing iris with holder - Poids: 0.35 Kg 1 included	
PF1114	Ø165 mm metal filter holder 6 included	
SGUX	Universal "A" size gobo-holder (metal, glass, frosted glass) 1 included	
M165TP	6 ways "push/pull" colour changer - Poids: 2.09 Kg 1 included	
CP71/CP40	CP71/CP40 - G22 1000W 230V 200h 3200K lamp	
CP93	CP93 - G22 1200W 230V 200h 3200K lamp	
GT1000	Tripod stand - SWL: 40 Kg - max. height: 1550 mm - Poids: 9.27 Kg	
GT800	Tripod stand - SWL: 40 Kg - max. height: 1550 mm - Poids: 7.98 Kg	
T1000	TV spigot with followspots swivel head - Poids: 1.82 Kg	
T4000	Followspot mount for Ø50mm pipe (suspension or overhead) - SWL= 100 Kg - Poids: 4.88 Kg	
CAV600A	Double slot front cassette for 180x180mm accessories - Poids: 0.43 Kg	
T/1650DSXCW	SULLY 115W LED compartment with potentiometer and display - Cool White - 3 meter power cable with CEE 7/7 (2P+T NF/SCHUKO) connector - Poids: 2.33 Kg	
T/1650DSXWW	SULLY 115W LED compartment with potentiometer and display - Warm White - 3 meter power cable with CEE 7/7 (2P+T NF/SCHUKO) connector - Poids: 2.33 Kg	
T/1650SXCW	SULLY 115W LED compartment with potentiometer - Cool White - 3 meter power cable with CEE 7/7 (2P+T NF/SCHUKO) connector - Poids: 2.27 Kg	

T/1650SXWW	SULLY 115W LED compartment with potentiometer - Warm White - 3 meter power cable with CEE 7/7 (2P+T NF/SCHUKO) connector - Poids: 2.27 Kg	
T/600SX	Lamp compartment for 1000/1200W tungsten GX9,5 lamps - 3 meter power cable with CEE 7/7 (2P+T NF/SCHUKO) connector - Poids: 1.36 Kg	
VD120	120x120mm frosted glass	
Kit TELRAD	Telrad followspot sight with raiser and universal mounting kit - Poids: 1.23 Kg	
SDUP	Followspot cue sheet holder with universal mounting kit	
FC1124/S	Flight-case for Ultra Compact range / GT stand - Poids: 35 Kg	
W/GT800	Set of 3 wheels for GT800/1000 stand - Poids: 2.33 Kg	