

SULLY - 305CLF CW

305 - LED 115 W



- **Type:** Single lens luminaire
- **Source:** LED 115 W
- **Optics:** 150 mm Fresnel lens
- **Colour temperature:** Cool White
- **Standard:** 110 V North american

Single lens

The multi-purpose LED spot with interchangeable lens

Providing a multi-faceted solution in a compact package, Sully 305LF luminaire combines a high-quality 115W white LED source with a single 150 mm / 6" Fresnel lens, which can be easily changed for a Pebble Convex lens. It is especially valuable in multi-purpose venues and rental companies where the interchangeable lens can be put to full use. With uniform light and premium colour rendering, Sully Fresnel will easily substitute 1000W tungsten models. It is an affordable and lightweight unit with no compromise on build quality and overall performance.

Features

- **Theatre front cassette:** no light spill to distract audiences or performers
- **Accessories holder:** double runners to hold accessories and colour filters
- **Barn door:** unique rotating barn door with 4 individually rotating blades – makes even the most difficult angle possible
- **Adjustable response time:** choice of fast or slow dimming for tungsten-like simulation - adjustment by DMX protocol
- **Ethernet-DMX node:** data IN through RJ45 connector; data OUT through DMX for daisy chaining
- **Universal data control:** compatible with DMX, RDM, Art-Net, sACN protocols
- **Remote setup:** all parameters can be adjusted by RDM protocol or by web interface
- **PWM adjustment:** choice of different PWM dimming frequencies - continuous mode available
- **DMX:** 8 or 16 bit dimming and strobe function
- **Dimming parameters:** choice of square or linear dimming curves
- **Local setup (optional):** dMX address and mode, dimming curve and response time through 4-button display with automatic light switch-off
- **Focus reference:** index for easy focus reference
- **Focus adjustment:** smooth focus adjustment from rear
- **Tilt reference on hanging yoke:** index for rapid re-positioning

Optical

- **Long life:** outstanding operational lifetime expectation, no need to replace lamps, low maintenance
- **Wide angle:** up to 90° from edge to edge
- **Beam shaping :** efficient barndoors in any focus position
- **Choice of 2 lenses :** Fresnel or Pebble-Convex lens – requires a standard screwdriver only
- **Electronic dimmer:** dimming without clipping or cut-out at low intensity levels; high quality smoothing
- **No colour shift:** colour temperature remains the same when dimming

Construction

- **Made in France :** fully manufactured in Robert Juliat premises retaining complete control over all aspects of quality
- **PSU:** built-in electronic flicker-free power supply for easy, plug-and-play installation
- **Power connectors:** neutriK® powerCON TRUE1 TOP IN and OUT connectors for daisy chaining
- **Silent-running cooling fans:** ideal for TV studios and opera houses
- **Electronic thermal management system:** ensures maximum performance of the system without any risk of overheating
- **Bodywork:** strong sheet metal construction for durability
- **Captive knobs and handles:** additional security when working at height or in transit
- **Easy access to all parts:** easy cleaning and maintenance
- **Safety first:** front accessories safety cable attachment point

Picture:305LF

DSEN374_305CLF_CW - 05/06/2023

Robert Juliat reserves the right to change or alter any of the items detailed on this page, to increase or improve manufacturing techniques without prior notice.

Robert Juliat S.A.S., 32 rue de Beaumont, 60530 Fresnoy-en-Thelle - France
Telephone : +33 (0)3 44 26 51 89 - info@robertjuliat.fr - www.robertjuliat.com



ROBERT JULIAT



- Lamp type: LED
- Power: 115 W

| LED specifications | Power * | Lumen output* | Colour temperature* | CRI* |
|--------------------|---------|---------------|---------------------|------|
| LED 115W CW | 115 W | 14 300 lm | 5700K | 93 |

(*) manufacturer's data

Optics

Characteristics

- Type: Single lens
- Beam range: 7° to 50°
- Lens: 150 mm Fresnel lens

Gel filter

- Shape: Square
- Standard size: 180x180 mm (7.1x7.1")

Photometrics (Photometrics report(s) available at the end of the document)

optics: 7°-50° / Standard

• Optics @ 7°

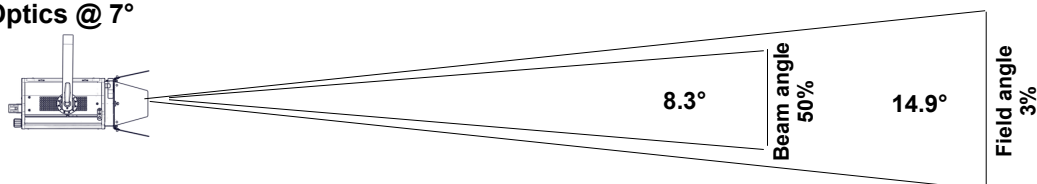

Beam intensity
123 100 cd

Field lumens
2 710 lm

Efficacy
21 lm/W

| | | | | | | |
|--------------|------------|-----------|-----------|-----------|---------|---------|
| Distance | 3 m | 5 m | 7 m | 10 m | 12 m | 15 m |
| Diameter | 0.8 m | 1.3 m | 1.8 m | 2.6 m | 3.1 m | 3.9 m |
| Illumination | 14 000 lux | 4 950 lux | 2 550 lux | 1 250 lux | 860 lux | 550 lux |
| Distance | 10 ft | 15 ft | 25 ft | 35 ft | 40 ft | 50 ft |
| Diameter | 2.6 ft | 3.9 ft | 6.5 ft | 9.2 ft | 10.5 ft | 13.1 ft |
| Illumination | 1 250 fc | 550 fc | 200 fc | 110 fc | 80 fc | 50 fc |

• Optics @ 50°

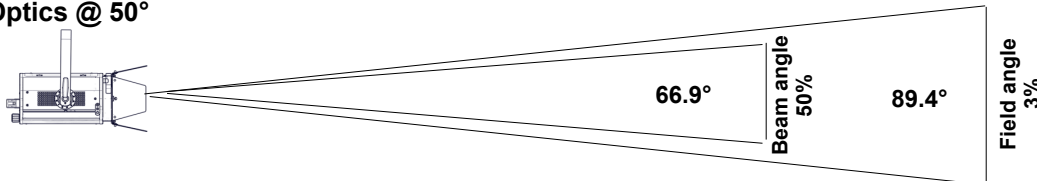

Beam intensity
9 500 cd

Field lumens
10 420 lm

Efficacy
81 lm/W

| | | | | | | |
|--------------|-----------|---------|---------|---------|---------|--------|
| Distance | 3 m | 5 m | 7 m | 10 m | 12 m | 15 m |
| Diameter | 5.9 m | 9.9 m | 13.9 m | 19.8 m | 23.7 m | 29.7 m |
| Illumination | 1 100 lux | 390 lux | 200 lux | 100 lux | 70 lux | 43 lux |
| Distance | 10 ft | 15 ft | 25 ft | 35 ft | 40 ft | 50 ft |
| Diameter | 19.8 ft | 29.7 ft | 49.5 ft | 69.3 ft | 79.2 ft | 99 ft |
| Illumination | 100 fc | 43 fc | 16 fc | 8 fc | 6 fc | 4 fc |

Remote control

- Data protocol: USITT DMX512-A
RDM / Art-Net / sACN

- Data IN connector: 5 pins XLR mâle + etherCON RJ45
- Data OUT connector: 5 pins XLR femelle



• DMX chart:

Mode 1 (1 channels)

Dimmer

Mode 2 (2 channels)

Dimmer
Dimmer fine

Mode 3 (5 channels)

Dimmer
Strobe duration
Strobe speed
Response time
Control mode

Mode 4 (6 channels)

Dimmer
Dimmer fine
Strobe duration
Strobe speed
Response time
Control mode

Dimensions and weight

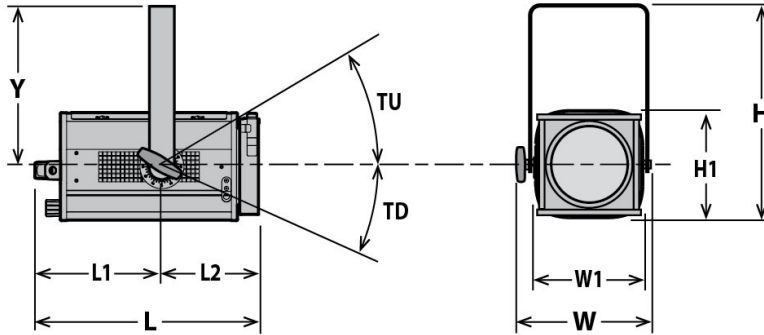

Weight: 9.15 kg (20.1 lbs)

| Height | Length | Width | Yoke | Tilt |
|---------------------|---------------------|---------------------|---------------------|---------|
| H= 387 mm (15.2 in) | L= 423 mm (16.7 in) | W= 304 mm (12 in) | Y= 283 mm (11.1 in) | TU= 90° |
| H1= 212 mm (8.3 in) | L1= 231 mm (9.1 in) | W1= 208 mm (8.2 in) | | TD= 90° |
| | L2= 192 mm (7.6 in) | | | |

Shipping

- **Weight :** 10.3 kg (22.7 lbs)
- **Volume :** .04 m³ (1.48 ft³)

Installation

- **Minimum distance to illuminated surface:** 0.2 m (0.7 ft)
- **Operating position:**

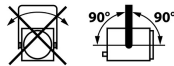

Construction

- **Housing:** Steel sheet - Aluminium
- **Colour:** Black
- **Cooling:** Low noise variable fan
- **Maximum ambient temperature (Ta):** 40°C (104°F)
- **Maximum case temperature (Tc):** 62°C (143.6°F)
- **Total heat dissipation:** 461 BTU/h
- **Ingress Protection (IP) rating:** IP20

Electrical compatibility

- 220/230 V - 50 Hz
- 245 V - 50 Hz
- 110/120 V - 60 Hz
- 208 V - 60 Hz
- 220/230 V - 60 Hz
- 100 V - 50 Hz
- 100 V - 60 Hz
- Selector: automatic detection

Power input



- **Type:** removable power cord with Neutrik powerCON TRUE1 TOP connector (included)
- **Cable:** 14 AWG SJ type (UL/CSA)
- **Length:** 1.5 m (4.9 ft)
- **Power connector:** without connector

Power consumption

| Voltage | Frequency | Current | Power | Power factor |
|---------|-----------|---------|-------|--------------|
| 120 V | 60 Hz | 1.15 A | 135 W | 0.98 |
| 230 V | 50 Hz | 0.7 A | 130 W | 0.81 |
| 100 V | 60 Hz | 1.4 A | 135 W | 0.96 |

Power Supply Unit

- **PSU:** Internal - Electronic PSU - Flicker free with PFC
- **Control:** / DMX
- **Protection:** Mains: 2x 6.3A 5x20 T fuses /
- **Power thru:** Neutrik powerCON TRUE1 TOP - Maximum of 22 units (230 V) / 12 units (120 V)

Warranty

- **Fixture: 3 years**
See General Sales Condition on website

Approvals



Acoustics

- **Noise level:** < 24 dB(A)









Model

| | |
|------------------|--|
| 305CLF CW | LED 115 W Single lens luminaire - 150mm Fresnel - 305CLF CW Sully - Cool White - North american standard |
|------------------|--|

Options

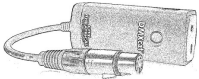
| | | |
|--------------|--------------------------------------|---|
| DISP1 | Display and keyboard for local setup |  |
|--------------|--------------------------------------|---|

Accessories

| | | |
|------------------|--|---|
| PF500M2 | 180x180mm metal filter holder 1 included |  |
| CF500 | 4 rotating leaves on a rotating barndoor - 180x180mm (without safety cable) - Poids: 0.82 Kg |  |
| L150 PB/2 | Ø150mm Pebble convex lens with double slot front cassette for 180x180mm accessories - Poids: 1.25 Kg |  |
| TH600 | 180x180mm "Top hat" (without safety cable) - ø150mm / 150mm long |  |
| DMXcat | Bluetooth DMX/RDM Multifunction test tool - City Theatrical DMXcat® |  |
| 876 | Hook clamp 40x10mm with 28mm M10 screw for Ø35 to 50mm pipes - SWL: 50Kg - Poids: 1.25 Kg |  |
| 880 | Hook clamp 40x10mm with 28mm M10 screw for Ø50 to 63mm pipes - SWL: 50Kg - Poids: 1.36 Kg |  |
| CS2 | Safety cable Ø3 mm L= 600mm - SWL: 75 Kg |  |
| CS5 | Safety cable Ø1,5 mm L=300mm for front accessory with karabiner and quick link - SWL: 25 Kg |  |

• Optics @ 7°

| Field lumens | Beam lumens | Efficacy | Beam intensity | CCT | Delta uv |
|--------------|-------------|----------|----------------|---------|----------|
| 2 710 Lm | | 21 Lm/W | 123 100 Cd | 5 440 K | |

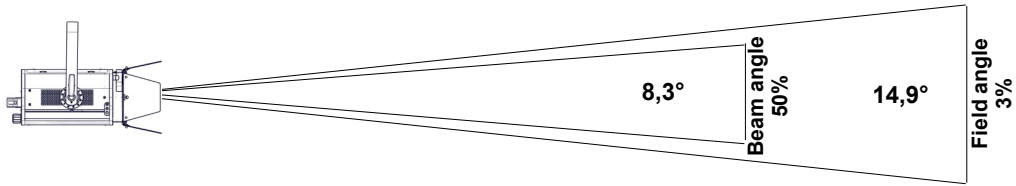

| | | | | | | |
|----------------|------------|-----------|-----------|-----------|---------|---------|
| Distance | 3 m | 5 m | 7 m | 10 m | 12 m | 15 m |
| Field diameter | 0,8 m | 1,3 m | 1,8 m | 2,6 m | 3,1 m | 3,9 m |
| Illumination | 14 000 lux | 4 950 lux | 2 550 lux | 1 250 lux | 860 lux | 550 lux |
| Distance | 10 ft | 15 ft | 25 ft | 35 ft | 40 ft | 50 ft |
| Field diameter | 2,6 ft | 3,9 ft | 6,5 ft | 9,2 ft | 10,5 ft | 13,1 ft |
| Illumination | 1 250 fc | 550 fc | 200 fc | 110 fc | 80 fc | 50 fc |

• Optics @ 35°

| Field lumens | Beam lumens | Efficacy | Beam intensity | CCT | Delta uv |
|--------------|-------------|----------|----------------|---------|----------|
| 6 390 Lm | | 50 Lm/W | 16 800 Cd | 5 440 K | |

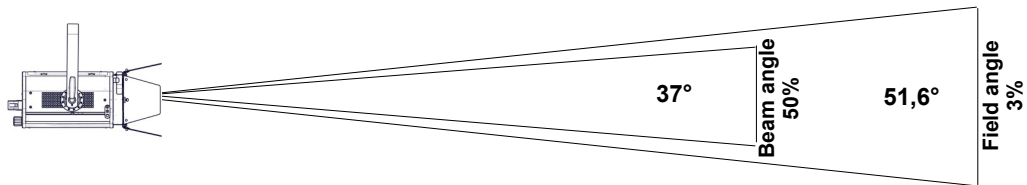

| | | | | | | |
|----------------|-----------|---------|---------|---------|---------|---------|
| Distance | 3 m | 5 m | 7 m | 10 m | 12 m | 15 m |
| Field diameter | 2,9 m | 4,8 m | 6,8 m | 9,7 m | 11,6 m | 14,5 m |
| Illumination | 1 900 lux | 680 lux | 350 lux | 170 lux | 120 lux | 75 lux |
| Distance | 10 ft | 15 ft | 25 ft | 35 ft | 40 ft | 50 ft |
| Field diameter | 9,7 ft | 14,5 ft | 24,2 ft | 33,8 ft | 38,7 ft | 48,3 ft |
| Illumination | 170 fc | 75 fc | 27 fc | 14 fc | 11 fc | 7 fc |

• Optics @ 50°

| Field lumens | Beam lumens | Efficacy | Beam intensity | CCT | Delta uv |
|--------------|-------------|----------|----------------|---------|----------|
| 10 420 Lm | | 81 Lm/W | 9 500 Cd | 5 470 K | |

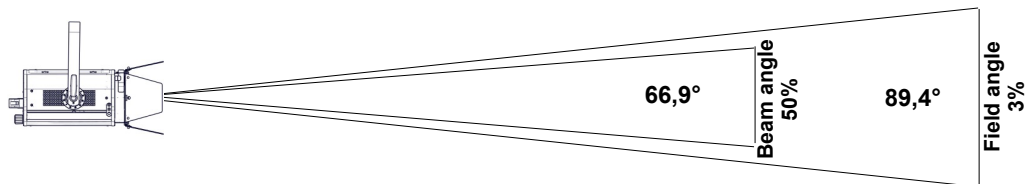

| | | | | | | |
|----------------|-----------|---------|---------|---------|---------|--------|
| Distance | 3 m | 5 m | 7 m | 10 m | 12 m | 15 m |
| Field diameter | 5,9 m | 9,9 m | 13,9 m | 19,8 m | 23,7 m | 29,7 m |
| Illumination | 1 100 lux | 390 lux | 200 lux | 100 lux | 70 lux | 43 lux |
| Distance | 10 ft | 15 ft | 25 ft | 35 ft | 40 ft | 50 ft |
| Field diameter | 19,8 ft | 29,7 ft | 49,5 ft | 69,3 ft | 79,2 ft | 99 ft |
| Illumination | 100 fc | 43 fc | 16 fc | 8 fc | 6 fc | 4 fc |

Light quality report

| CCT | DeltaUV | CRI Ra | CRI R9 | CQS Qa | TM30-18 Rf | TM30-18 Rg | TLCI | SSI [D5659] |
|--------|---------|--------|--------|--------|------------|------------|------|-------------|
| 5 660K | 0.0030 | 93 | 60 | 93 | 92 | 102 | 90 | 71 |

CRI - CIE Colour Rendering Index

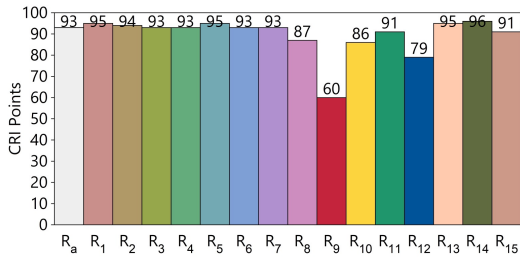

TLCI - Television Lighting Consistency Index

Test : CCT = D5659 (0,0)
 TLCI-2012 : 90 (D5659)

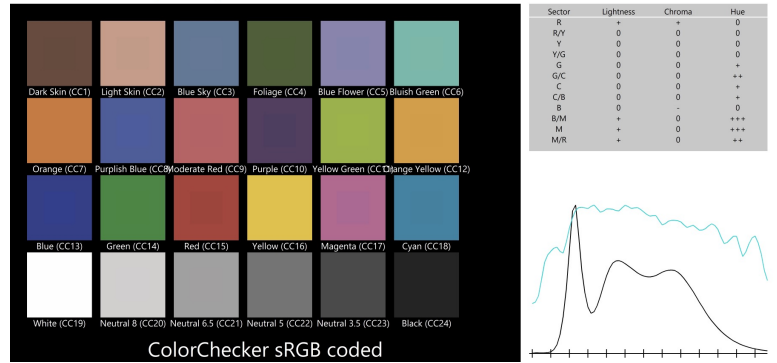

CQS - NIST Colour Quality Scale

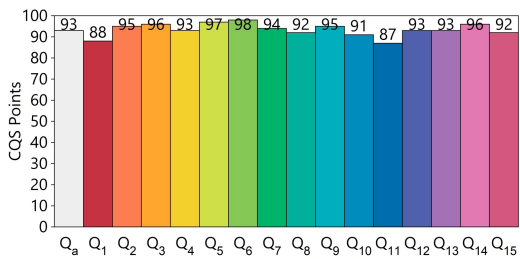

ANSI/IES TM-30-18 Colour Rendition Report

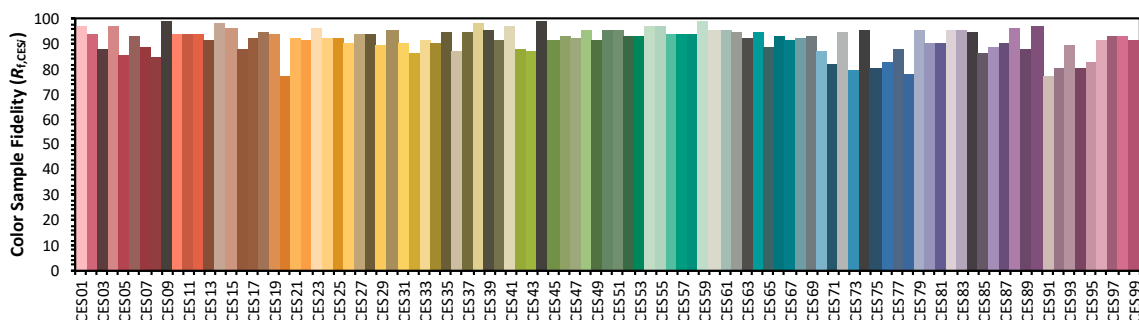
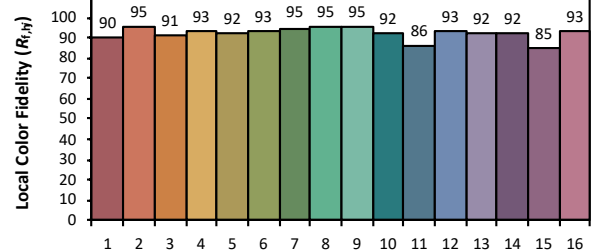
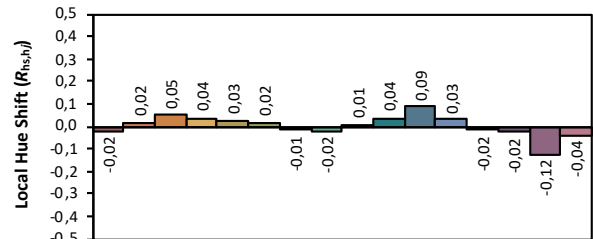
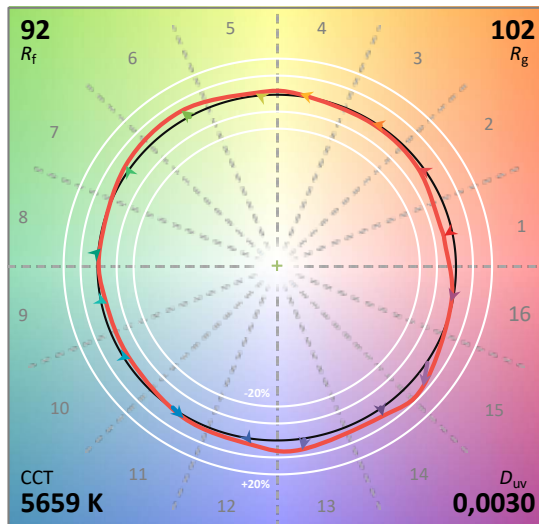
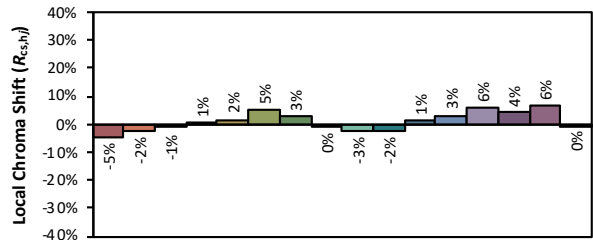
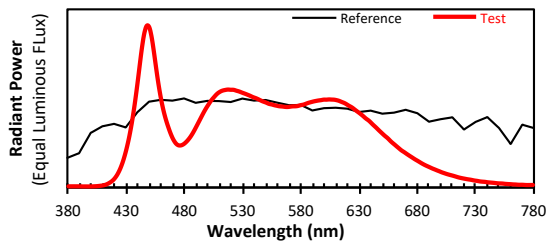

Colours are for visual orientation purposes only. Created with the IES TM-30-18 Calculator Version 2.00